

## CHAPTER 29

### TARGETRY

### INTRODUCTION

2901. **Aim.** This chapter covers the provision, description and maintenance of targetry approved by the Sponsor for use on the ranges described in previous chapters of this Volume and in particular:

Introduction	2901 - 2903
Provision	2904 - 2907
Figure target mechanisms	2908 - 2915
Anti-tank targets	2916 - 2920
Targets and accessories	2921 - 2926
Target holdings	2928
Maintenance	2929
Targets and other rail systems	2930

2902. **Definitions.** Targetry is the fitted, non-constructed, part of a range and includes:

- a. **Targets.** Targets are the consumable materials struck by shot. They include pre-formed targets and the basic materials for making up targets.
- b. **Target Mechanisms.** These expose targets on command and may be operated manually, by radio when portability is required or by land line when a mains supply is available at fixed installations. Mechanisms may be single or multiple function devices, the latter having the ability to move. Details of manually operated mechanisms are given in the relevant range chapters.
- c. **Support Systems.** These are ancillary systems, such as the Automatic Marker System (AMS), which measures the fall of shot on and around a target by acoustic triangulation and displays the results on individual monitors, Enemy Fire Simulators (EFS) and Visual Hit Indicators (VHI).

2903. **Design Criteria.** The use of the approved targetry listed in this Chapter is essential to the safety of a fixed range as the type, position and size of targets are principal considerations in range design. LofS, QE and ricochet determine range geometry, which may be adversely affected if unapproved targetry is used.

### PROVISION

2904. **Sponsor.** Sponsorship and funding of targetry systems for SA and IWS used on military land ranges for all the Services, including Reserves and Cadets, is the responsibility of Defence Equipment Capability (Ground Manoeuvre) (DEC(GM)), under the Deputy Chief of the Defence staff (Equipment Capability) (DCDS(EC)). The sponsor also approves such targetry for Service use. This currently excludes manually operated and

indoor range mechanisms, as the construction of specialist buildings to house targetry.

**2905. Target Mechanisms and Support Systems.** Joint and Battlefield Trainers, Simulation and Synthetic Environments Integrated Project Team (JBTS IPT) of Defence Equipment and Support (DE&S) procures and funds on the authority of the Sponsor:

- a. Target mechanisms and support systems, including when appropriate, their installation and the training of operators and maintenance staff.
- b. Spares and spare parts for new mechanisms and support to those systems on their introduction into service. Thereafter it is the responsibility of the Defence Estates Training Estates – through Defence Training Estate (DTE) Strategic Support contract.
- c. The RAU is responsible for providing and funding both manually operated and indoor range mechanisms, and any specialist buildings to house target systems, and approving them for Service use.

**2906. Redeployment, Repair and Maintenance.** HQ DTE is responsible for re-deploying, funding and providing the repair and maintenance of approved in-service target mechanisms and support systems.

**2907. Consumable Materials.** Consumable materials will be procured by Construction Resources, Expeditionary Campaign Infrastructure IPT (ECI IPT) The procedure for demanding materials is:

- a. **Material Codified.** Normal supply chain using Form AFG 8620 to ECI IPT.
- b. **Material Not Codified.** Non codified material can be procured and supplied by the ECI IPT provided that funding is found by the demanding unit.

**Note:** Materials are listed in The Catalogue of Targetry Consumables, published by Battlefield Support. ESS IPT (Army Code 13535)<sup>1</sup> and can be viewed through the DTE website on the RLI : [www.land.army.r.mil.uk/lwc/pages/ate/documents/Cotc.pdf](http://www.land.army.r.mil.uk/lwc/pages/ate/documents/Cotc.pdf)

- c. Non-specific timber to repair and construct targets is demanded from DMC H3 NIV in the Medical Support and General Stores IPT (MS & GS IPT)

## FIGURE TARGET MECHANISMS

### STATIC

**2908. Fixed Electric Target (FET).** The FET is an electrically operated target presentation system. Targets are raised by an operator at a console and may be set for a required exposure period or to fall-when-hit. An electronic counter records hits. Each mechanism will lift up to three targets using a triple target bar conversion. FET require to be set into protected,

<sup>1</sup> Published by the Battlefield Support, Engineer Systems Support IPT (BS ESS IPT) which is now the responsibility of the ECI IPT. This catalogue is due to be updated in late 2009.

properly drained concrete housings and protected against rodents and vandalism. A power supply and signal cabling are needed. Construction details are contained in Type Drawings. Complex Combined Equipment Schedule (CES) No.40731 Fixed Electrical Target Ranges lists the components and it is sub-divided into:

- a. CES No.38814 - Target Holding Assembly, Electric, Fixed, 240 V AC (B2/6920-99-200-9072) or Target Holding Assembly, No. 1, Electric, Fixed, 240 V AC (B2/6920-99-105-6283).
- b. CES No.38815 - Console Target Control, Fixed, 24 V DC (B2/6920-99-200-9701).
- c. CES No.38917 - Conversion Kit, Target Holding Assembly, Electric (B2/6920-99-961-4355).
- d. CES No.38920 - Parts Kit, Target Holding Assembly, Electric (B2/6920-99-961-8181).

2909. **Small Arms Range Targetry System (SARTS).** From 2010, Ranges equipped with FETs will be replaced by new targetry under project SARTS. SARTS will provide automatic marking and coaching tools, allowing near real time feedback to the coach or firer to all ETR and CGR ranges. SARTS conversion is to be complete by 2014 to all electric ranges.

2910. **Electric Swivel Target Equipments.** These electrically operated mechanisms replace the traditional hand operated turners. Banks of two or three targets per lane are turned through 90° (1600 mils) by an operator using a hand-held console, which is connected by a cable to the mechanisms, to expose the targets to the firers. The mechanisms are placed behind a mantlet so that no part of them is visible to a firer in any firing position on any firing point. Power supply is either 12 V batteries or mains transformed to 12 V DC. Although not strictly portable, the mechanisms can be moved to and from a store.

2911. **Portable Radio-Operated Target Equipments.** These are primarily used for field firing exercises. They may provide a number of features such as fall-when-hit, hit counters and displays, and have retaliatory devices. Targets are radio-controlled with a multi-link possibility. The equipment has to be well dug in or shielded by a bank or bund so that no part of the mechanism, including the target arm, is visible to a firer in any firing position from any firing point. A minimum of 500 mm of well compacted earth protection or sandbags is required, although this will require review when new weapons are brought into service. If the unit is only splash-proof and is to be left in a pit, drainage will be necessary.

**Note:** Radio controlled target mechanisms present a danger to users if not properly handled. Detailed preparation instructions and safety precautions are contained in the User Instructions.

#### 2912. **Portable Cable Operated Equipment**

- a. **Description.** If FET installation is impracticable, portable cable-operated electric targets provide a fall when-hit- capability but have no up-and-hold facility which may be unsuitable for some practices. Installation is carried out by the range staff or user unit referring to the

engineering instructions. The equipment is supplied to CES No.38880 - Target Set Silhouette, Portable, Electrical/Pneumatic, (B2/6920-99-106-9201) and comprises:

- (1) 12 target mechanisms and a console.
- (2) 36 drums of 100 m long electric cable with connectors.
- (3) A 3 m lead with crocodile clips to connect the console to the battery.
- (4) 4 drum carrying handles.

b. **Compressed Air Supply.** Each mechanism is operated by compressed air and has two air cylinders. Compressors for charging the cylinders are shown in Table 1:

Type	Vocabulary No.	Description
(a)	(b)	(c)
Static	W2/WX/0415	Plant, Dry Air Charging, Static, S.I. Engine Driven, 5 c.f.m/2500 p.s.i., Reavell, SAT3, Coventry Climax
Mobile	W2/4310/99/205/93 13	Plant, Dry Air Charging, Mobile, Engine Driven, Bristol Pneumatic Tools Ltd. Model BM 4S-7

**Table 1 - Air Compressors**

### MOVING

2913. **Mechanised Moving Target Trainer.** Produced by RX Products Ltd., this system has up to six trolleys which are towed on a straight rail track by an electric winch at four selected speeds between 0.8 and 4.0 m/s. Targets are erected on the trolleys which traverse a 10 m lane, starting and finishing behind cover. The equipment is intended for permanent installation and forms the basis of the MMTTR. Installation and construction are in accordance with Type Drawing No.55743/2. The original manufacturer is no longer in business. MMTTR will be replaced by SARTS between 2010 and 2014 which will provide AMS feedback to moving targetry.

2914. **Moving Target Trolleys (Infantry) ATA Mk III Pannier.** Commonly known as the Moving Target System (Rural) or MTS(R), this radio-controlled mono-rail system has a trolley which can travel up to 30 m. The fall-when-hit targets are mounted in panniers but currently there is no hit recorder. MTS(R) is the last target on IBSR and may also be used on field firing ranges in a variety of layouts. The track is relatively simple to install and should have a sound level foundation. A mantlet with a minimum depth at the crest of 500 mm and of sufficient height is required to ensure that no part of the mechanism is visible to a firer in any firing position on any firing point.

2915. **SAPU AND SAM.** The Lockheed Martin Small Arms Pop-up (SAPU) and Small Arms Moving (SAM) Target System has been issued to most field firing ranges, to overseas training teams and a small pool is held by the Support and Repair contractor at Netheravon Down, near Netheravon in Wiltshire. This equipment is lightweight, portable and programmable and

provides the user with the ability to plan, construct and conduct realistic field firing exercises. The operational/training pool is allocated by HQ DTE – SO2 Targetry.

### ANTI-TANK TARGETS

2916. **General.** There are four categories of Atk targets:

- a. Static hard.
- b. Static soft.
- c. Moving hard.
- d. Moving soft.

2917. **Static Hard**

a. **Targets.** A variety of equipment and construction can be used such as:

- (1) AFV hulks, the target of choice; use can be prolonged by filling with compacted soil or lean mix concrete.
- (2) Heavy steel plating, preferably armoured; scrap plating from warships has been used.
- (3) Solid concrete constructions, whether reinforced or not, set into the ground.
- (4) Integrated construction of built-up dry bonded units to simplify replacing damaged sections.
- (5) Interlocking steel plating supported on a framework.
- (6) Light man-manageable steel plating clipped or slotted together to ease changing individual plates as shown in Figures 29-1 and 29-2.

**Note:** Materials other than steel break down leaving a rubble which has to be regularly removed.

b. **Stop Butts.** Stop butts may be provided to initiate rounds which miss the target or pass through holes in it. Careful planning and siting will considerably reduce the number of blinds.

2918. **Static Soft.** Targets of light penetrable material, such as a light timber frame with infills of mesh, hessian, plywood etc, in the shape of a vehicle or a AFV may be used for practice inert munitions. To initiate a flash head indicator, targets of a light steel construction, typically 2.5 mm thick MS, will be required. Heating elements may be included to provide an IR signature.

2919. **Moving Hard.** These are seldom provided due to the difficulty of moving the weight. However, AFV hulks with serviceable running gear may be used. The in-service target system is Agile, which is radio controlled and winches a full sized hard target on a trolley on rails over short distances. Long tow of a target by an AFV or recovery vehicle is seldom used.

2920. **Moving Soft**

a. **General.** Moving soft targets are constructed the same as static

targets described in paragraph 2918. Systems used to move them include:

- (1) Winched or towed sledges.
- (2) Engine or electric motor powered trolleys on rails.
- (3) Winched or towed floats on an inland waterway or sea.
- (4) Gravity run on a prepared ramp or slope.

b. **Requirements.** The system should provide:

- (1) A constant target speed.
- (2) A speed range between 5 and 40 kilometres per hour (kph) with intermediate speeds of approximately 12, 20 and 30 kph.
- (3) Target runs as direct crossing and oblique crossing. Head-on targets, both advancing and retreating, are mounted on sledges drawn by winch.

c. **In-Service Examples**

(1) **Wickham Trolley.** This rail mounted system is capable of taking heavy targets. Each trolley has an engine and runs in a loop being stopped by a trip in the track. The track can be laid to present the target at a variety of angles and speeds. It is a very reliable and solid system when the track is properly laid but changing the layout is difficult.

(2) **Agile Target System.** This is a skid-mounted sledge towed by a winch. An engine powered hydraulic motor drives the winch which may be manually or radio controlled. The cable is run round a circular system of pulleys with a cable tensioner suspended from a 5 m high derrick. The system needs little ground preparation but requires trained personnel to set up. When properly installed, it is simple and reliable, giving realistic target presentation with minimal protection required to the cable run and trolley. The system is considered to be portable.

(3) **Hima Sella (Theissen) System.** Targets, which can be either sledge or rail mounted, are pulled by a winch at speeds up to 60 kph. The system requires careful siting and installation, and is also considered to be portable.

d. **Equipment Protection.** If the natural shape of the ground cannot be used, mantlets will be required to prevent trolleys, track ways, cables and pulley points being damaged by firing. If track ways are excavated, the soil arising may be used to form the mantlets.

e. **Infrastructure.** On permanent installations a shed may be required at the end of the run to accommodate engines or winches and the target on its mover. Access roads, troop shelters, car parks and other ancillary installations are also likely to be required.

## TARGETS AND ACCESSORIES

2921. **Figure Targets.** Figure 11, 12, 14 and 20 targets are the basic range for military training and these are illustrated in Figure 29-3. Figure 11 and 12 targets are also available in reduced sizes to represent the full target viewed from a greater distance. Figure targets for use with AMS are shown in Figure 29-4. Targets Figure 21, 22, and 27 used to train personnel in Close Quarter Marksmanship are shown at Figure 29-6<sup>2</sup>. Other targets suitable for cadets are shown in Figure 29-5. Targets are issued in a variety of forms for particular applications. These include:

- a. **Colour.** Two colour variations are available: black and ochre and black and silver. The target type selected should provide the firer with the best opportunity to acquire the target with consideration made to range seasonal variations and the tactical exercise to be conducted.
- b. **Materials.** Plywood veneers with a printed paper facing for static (stick-in) use or fitting in GR Hythe frames and aluminium or plastic with a pre-printed facing for fall-when-hit mechanisms.
- c. **Scoring Circles.** Scoring circles are provided on targets for basic practices and for Army Rifle Association (ARA) competition shooting. They are not provided on fall-when-hit targets.
- d. **Optical/Iron Sights.** ARA target designs are varied to suit the type of sight being used.
- e. **Other Practices.** Targets are adapted to suit a variety of practices and training requirements such as grouping and zeroing, and multiple Figure 11 for LSW or GPMG.

2922. **1.22 m<sup>2</sup> and 1.83 m<sup>2</sup> Screen Targets.** A 1.22 m<sup>2</sup> (4 ft<sup>2</sup>) timber frame is covered with hessian and faced with ochre coloured paper to form a screen. A Figure 11 or 12 target facing is pasted in the centre as an aiming mark. The range of ARA targets is shown in Figures 29-6 and 29-7. Appropriate screen targets are also used for Stage 1 and 2 shooting and for cadet, National Rifle Association (NRA) and ARA competitions. 1.83 m<sup>2</sup> (6 ft) screens may be held for NRA and ARA shooting at distances over 400 m, for which Table 2 gives the scoring circle diameters that are marked with wax crayon.

---

<sup>2</sup> These target illustrations are preproduction sketches and do not represent the final in service version.

Ser	Figure Target	Figure 12				Figure 11 or 12
(a)	(b)	(c)	(d)	(e)	(f)	(g)
	Type	A	B	C	D	Stages 1 & 2 shooting
		500 m (mm)	300 m (mm)	200 m (mm)		
1	Series A (optic sight)	300 600 1200	180 360 750	120 240 750 1200	300 1200	760 1200
2	Series B (iron sight)	375 750 1200	225 450 750	150 300 750 1200	300 1200	760 1200

**Table 2 - NRA and ARA Scoring Circle Diameters**

2923. **Head-On Tank Target.** A 1.22 m<sup>2</sup> frame is faced in ochre with a black head-on tank silhouette (see Figure 29-8).

2924. **Representative Sizes.** Targets may be scaled to represent proportions presented at a notional distance, rather than the true engagement distance. Proportions may be calculated by applying the formula:

$$\frac{\text{Actual Target Dimension} \times \text{True Distance}}{\text{Representative Distance}} = \text{Representative Dimension}$$

**Example:** A Atk weapon is to be used at a true engagement distance of 100 m whereas the practice requires a representative range of 450 m. If the actual width of the tank target being engaged is 3.5 m, the representative width will be:

$$\frac{3.5 \times 100}{450} = 0.777 \text{ m or } 777 \text{ mm}$$

2925. **Falling Plates.** These are made of 8 mm thick armour plate, approximately 300 mm square and painted white. They are free standing on a narrow flange as shown in Figure 29-8, and their positioning and mounting are shown in Figure 15-11. Only the issued falling plates are authorised for use (see paragraph 2907 for demand).

2926. **RGGS HE Target.** The target illustrated in Figure 29-9 is constructed by range staff for which the details are given in Chapter 28.

2927. **Target Screens and Zeroing Targets.** In order to zero target rifles that have an ME exceeding 4500J on MOD ranges zeroing targets are to be fixed to screens mounted in gallery frames on gallery ranges. The club are to set sights for 600m for zeroing at 200m and check that the fall of shot at the point of impact is central on the target screen. Harmonisation and other targets screens used on barrack ranges are illustrated in Figure 29-5.



### Zeroing Target

#### TARGET HOLDINGS

2928. The types and quantities of targets held on a range will vary greatly and will depend on local demand. Ranges should not hold large stockpiles of targetry consumables but rather to demand as and when required to enable the procuring authority to efficiently use enabling contracts to meet demands. This will include regular and reserve forces, cadets and MOD Police (MDP) for training and competition. Only those targets and target mechanisms approved by the appropriate authority may be used (see paragraph 2903).

#### MAINTENANCE

##### 2929. Responsibilities

- a. **DE&S JBTSE IPT** provides spare parts for target mechanisms and new systems to IOC..
- b. **Equipment Manager (EM)**. In addition to the responsibilities stated in paragraph 2906, the EM is required to certify that target systems are safe after installation, repair and maintenance.
- c. **Targetry Support**. Approved targetry is supported through DTE's Strategic Partner contract by the Targetry Support Division of the Support Provider.
- d. **Range Staff**. Refer to Chapter 31.

**2930. Target and other Rail Systems.**

- a. JSP 790 – MoD Rail Safety Management Policy sets out the policy, key responsibilities, requirements, procedures and principles for the safety management of all MoD railway activity. JSP 790 can be accessed by using the following link [www.transportsafety.dii.r.mil](http://www.transportsafety.dii.r.mil).
- b. For the purpose of JSP 403, MoD Rail Safety Management Policy, JSP 790 applies to:
  - i. All personnel who are required to operate or work on MoD railway equipment and infrastructure (Including Permanent Way (PW) activity).
  - ii. All personnel who are involved in Target railway systems acquisition.
  - iii. All MoD rail activities that have the potential to endanger the health and safety of MoD personnel, the public and/or environment during normal operation, trials, training.
- c. Railway activities and/or operations pertaining to JSP 430 are identified as:
  - i. Equipment Management.
  - ii. Target Railways.
  - iii. Safety compliance, maintenance and disposal of MoD rail sites.
  - iv. Tenants undertaking work on MoD estate and/or railway infrastructure and equipment.
  - v. PW maintenance and construction.
  - vi. MoD rail activities at third party sidings/locations.
  - vii. Rail mounted testing facilities used as part of the UK and NATO European Regional Test Centre (ERTC) for the accreditation of small arms and cannon.

Reference: W

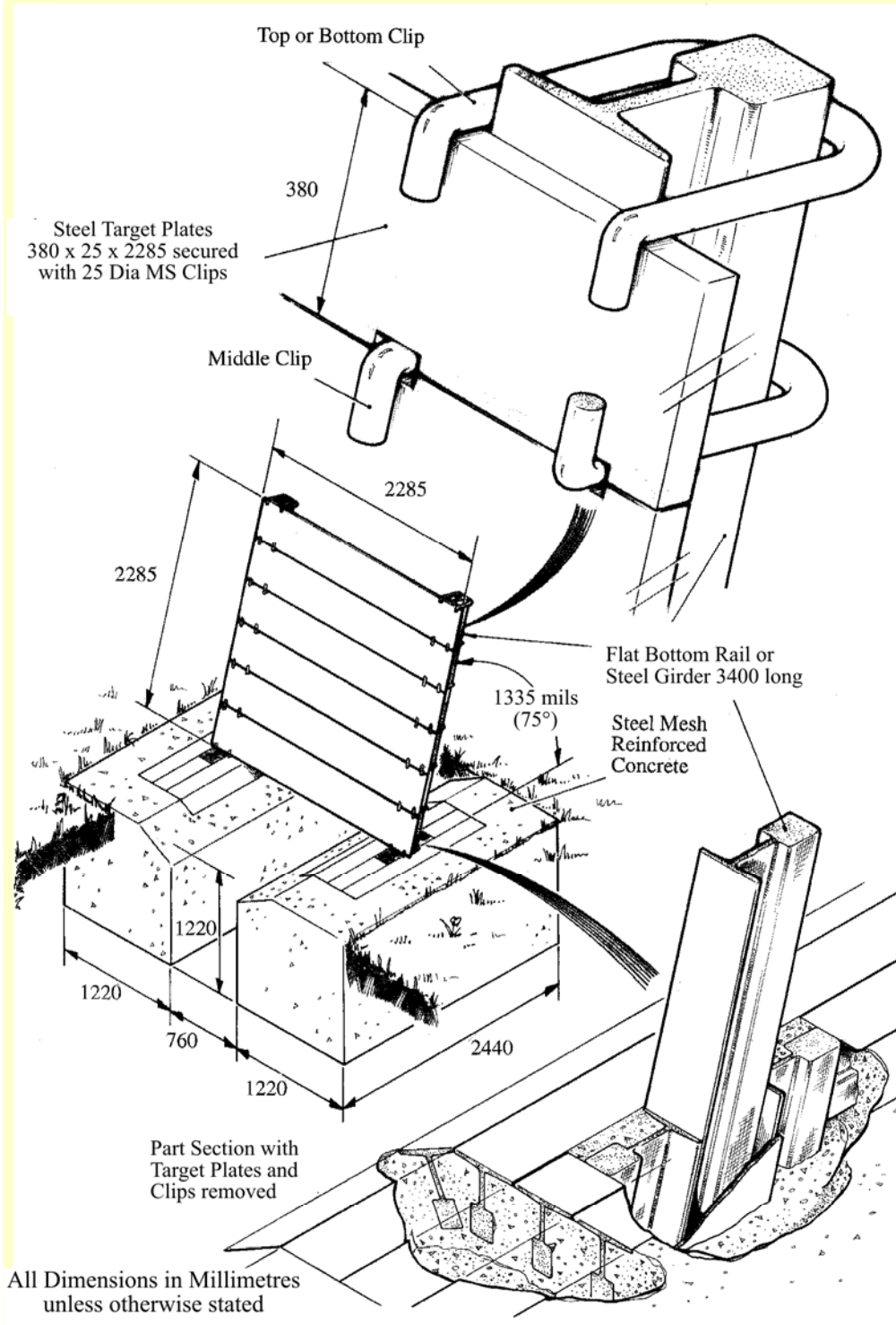

Figure 29-1. Horizontal Plate Hard Target

Reference: W

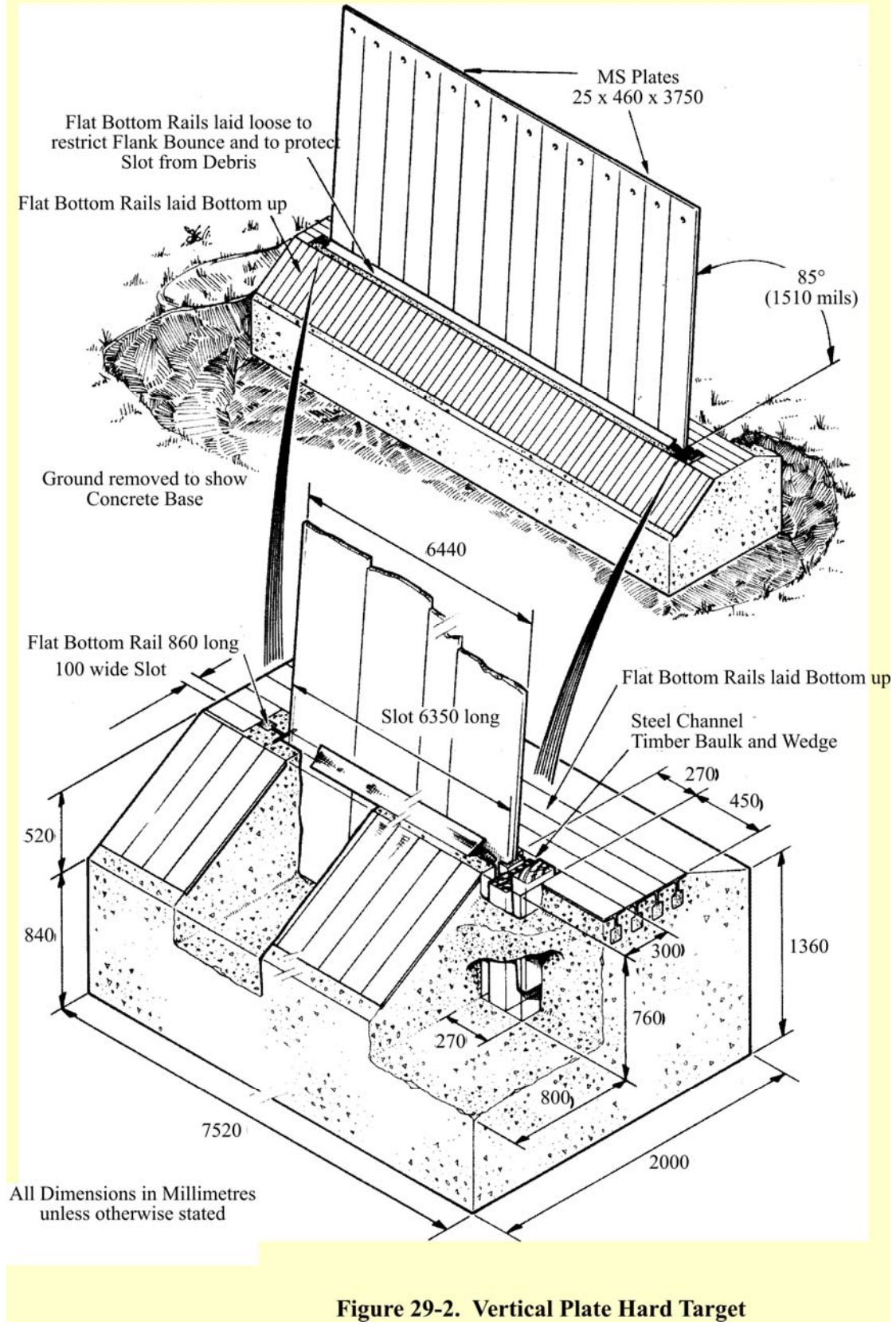

Figure 29-2. Vertical Plate Hard Target

Reference: W

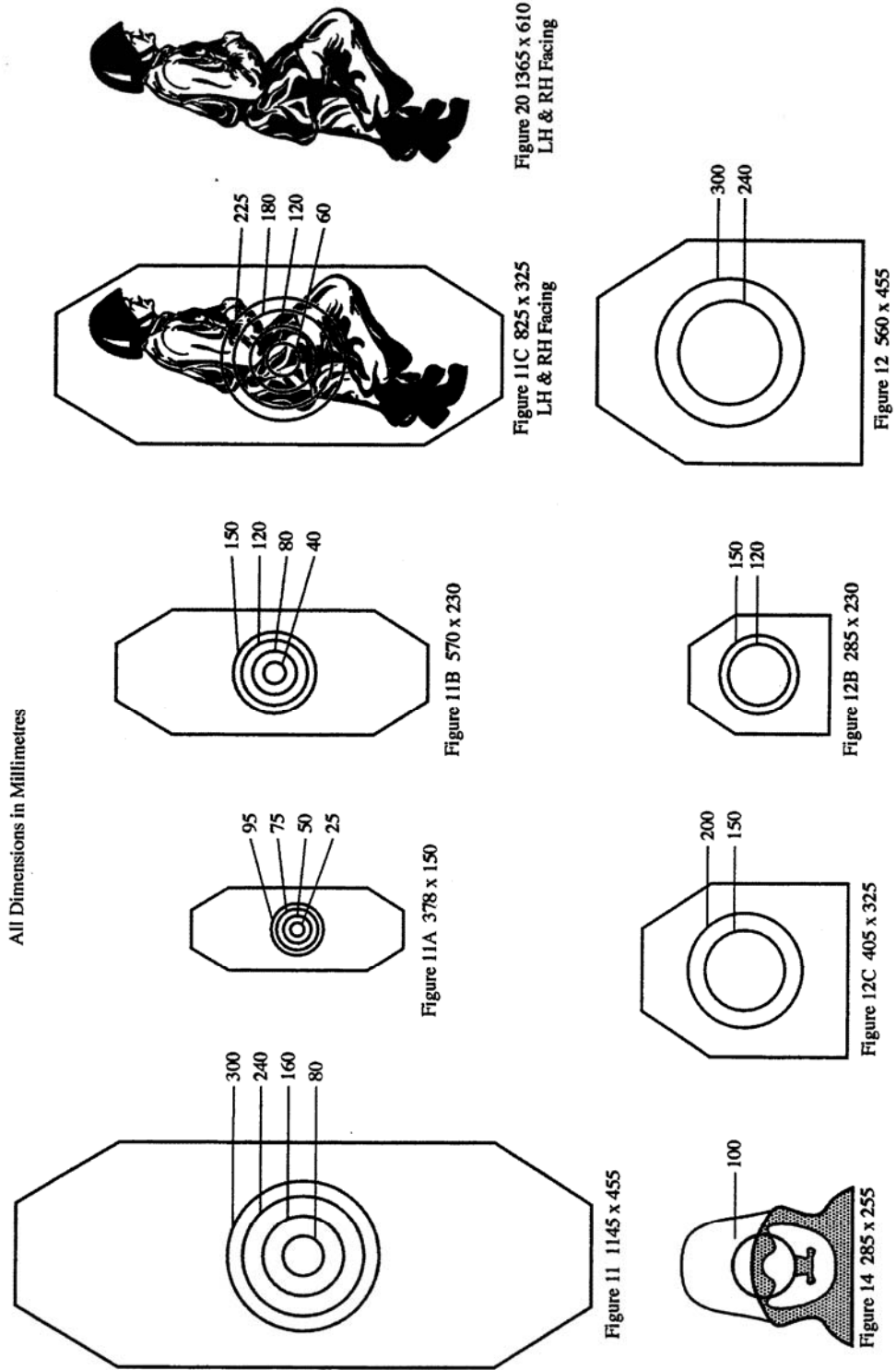
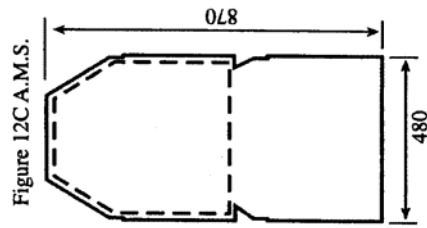
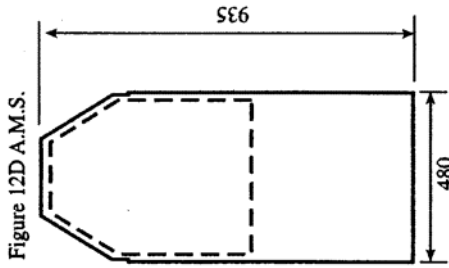
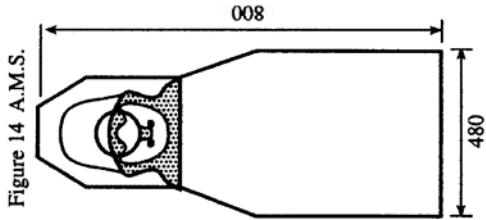

Figure 29-3. Standard Figure Targets

Reference: HQ LAND G3 Trg



All Dimensions in Millimetres

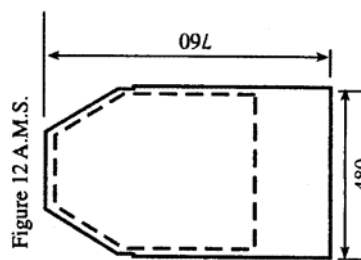
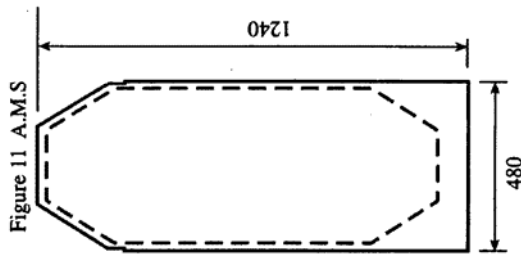
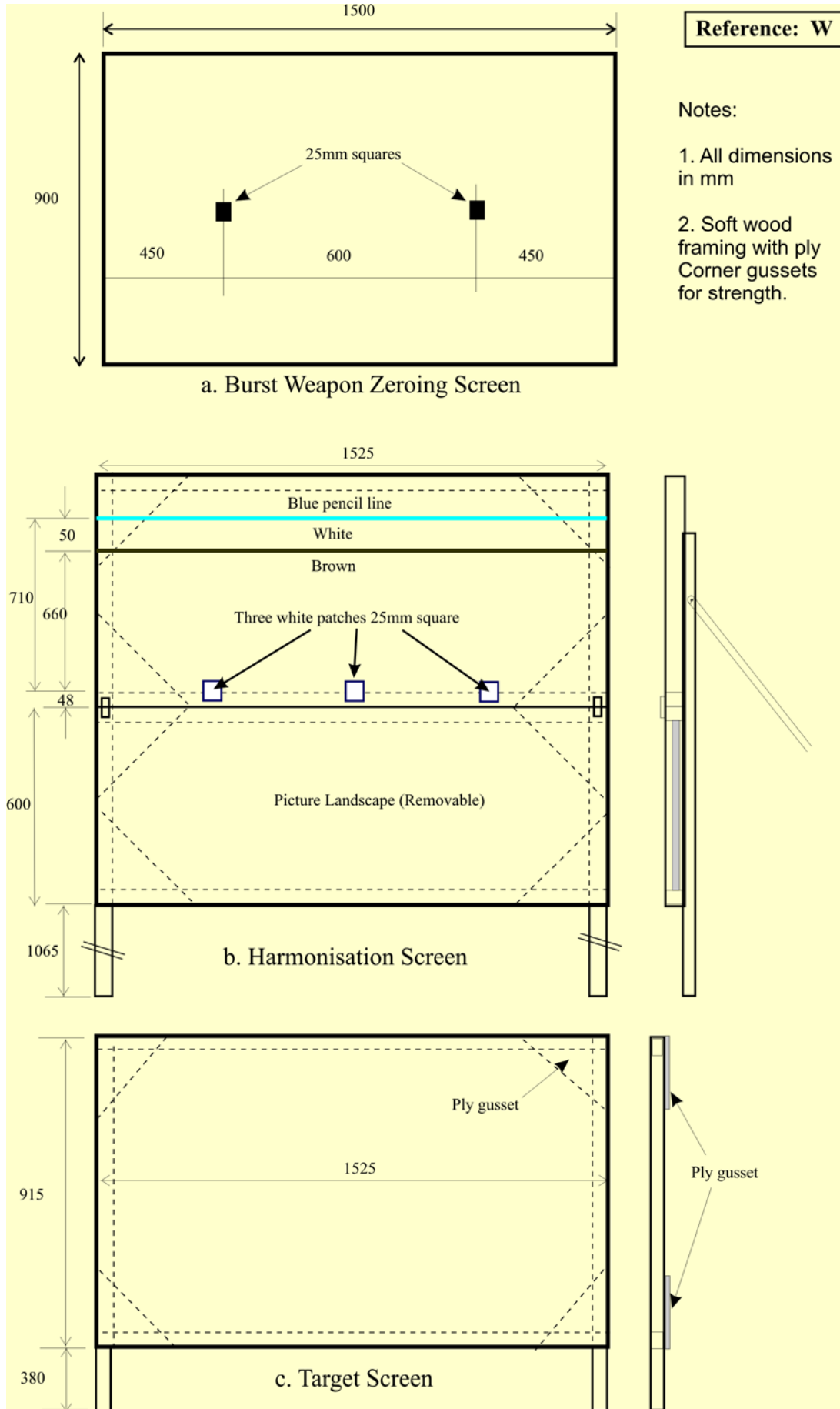
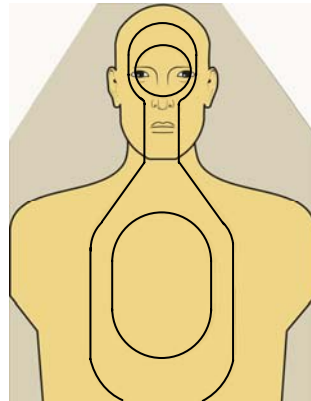
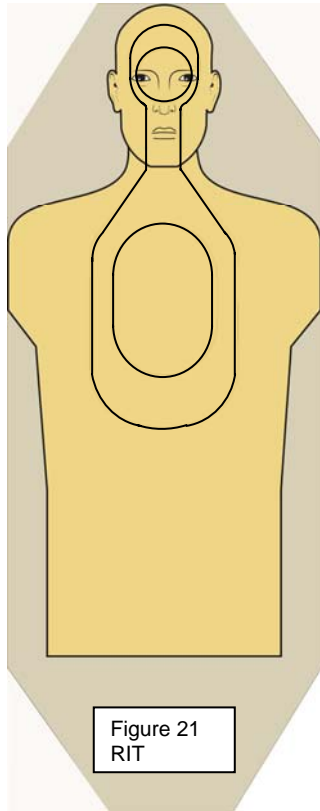

Figure 29-4. AMS Figure Targets



**Figure 29-5. Barrack Range Target Screens**



RIT = Rapid Incapacitation Target

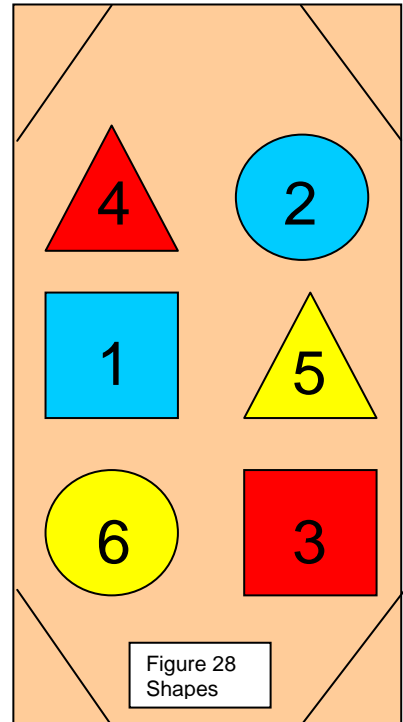
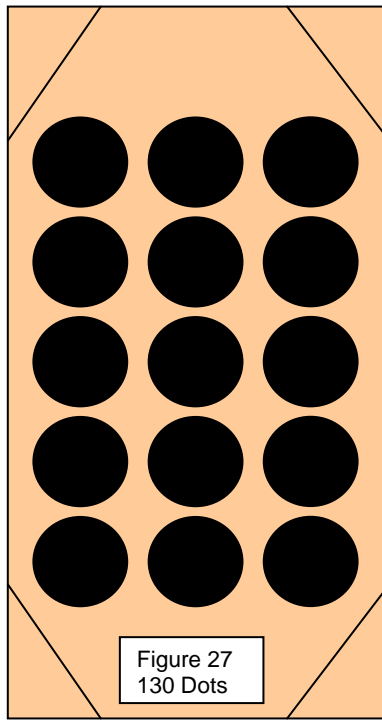
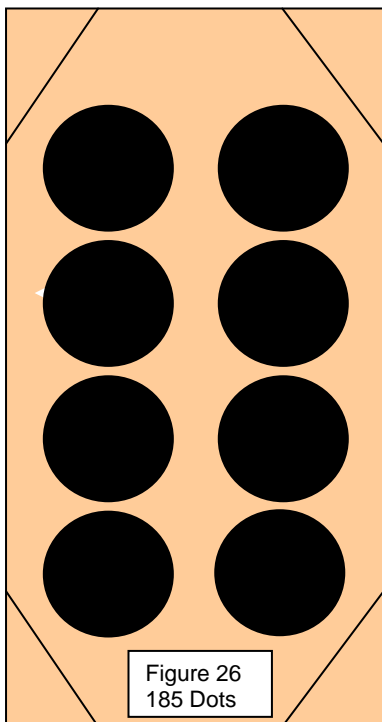

185 & 130 = dot diameter

Figure 29 – 6 CQM Targetry

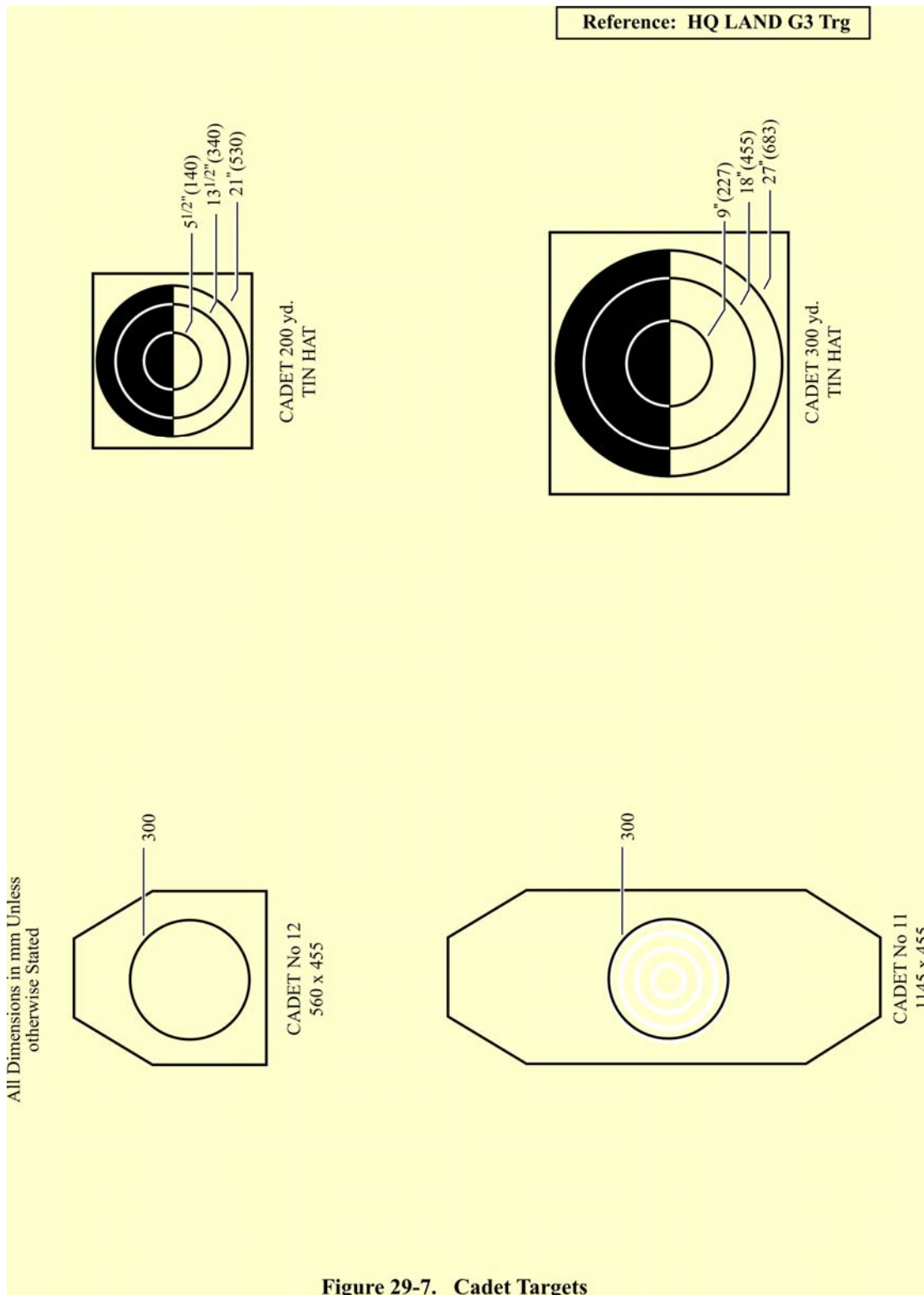

Reference: W

All Dimensions in Millimetres

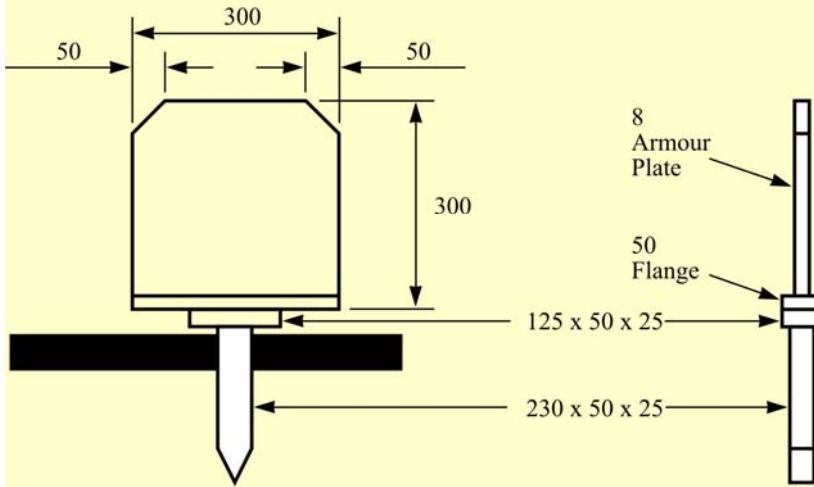

Falling Steel Plate  
(Catalogue of Royal Engineer Materiel  
Army Code 13535 Part No. 6920-99-439-0248)

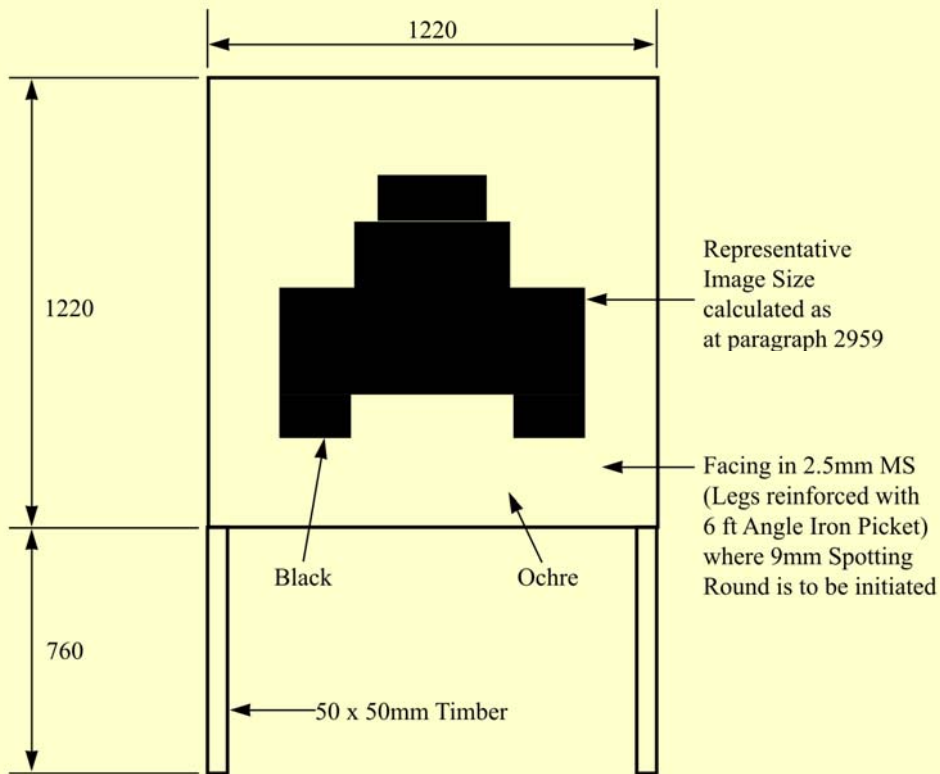

Head on Tank Target

Figure 29-8. Falling Plate and Head-On Tank Target

Reference: Type Standard SDS 040

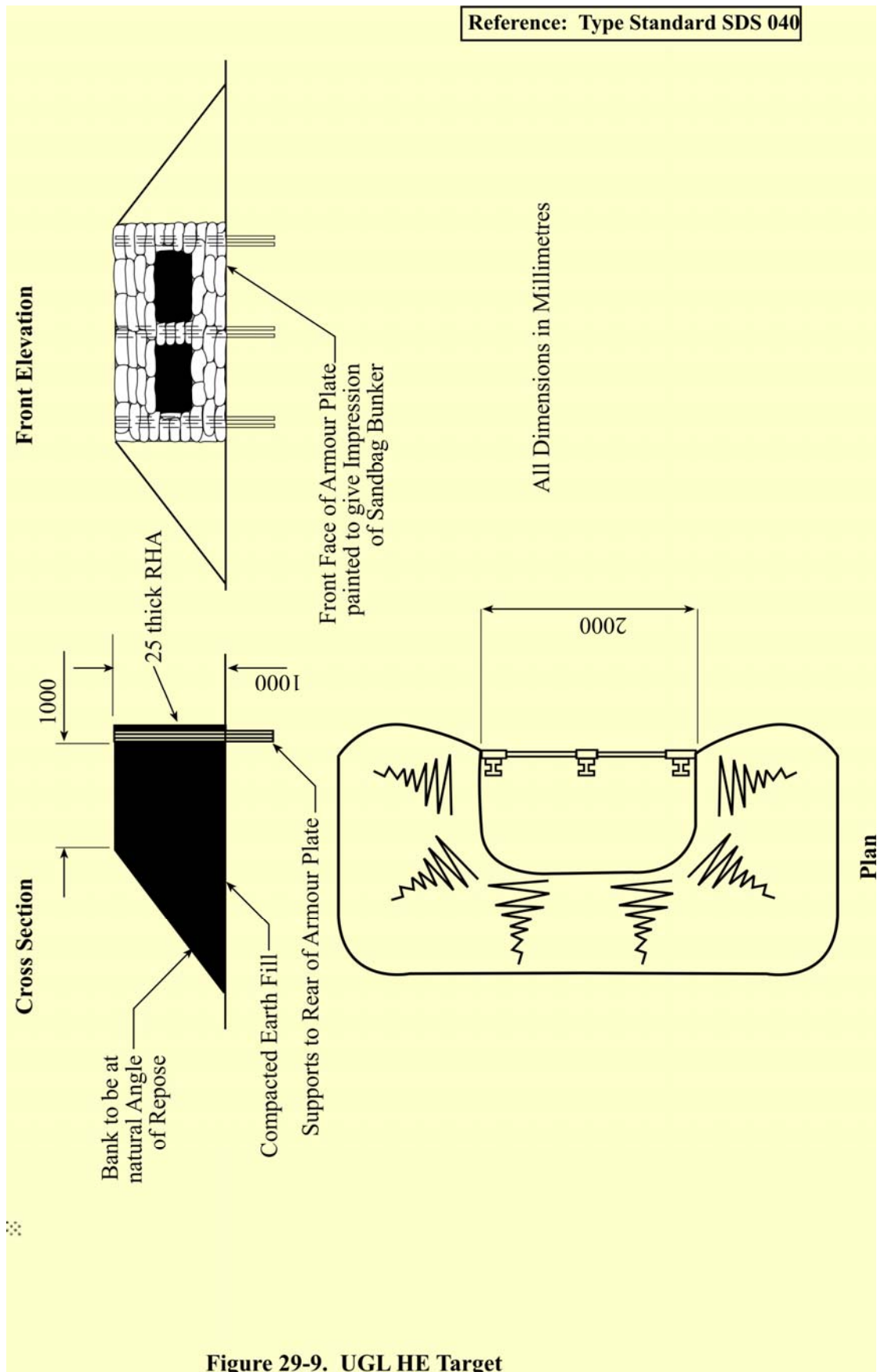

Figure 29-9. UGL HE Target