

# The MODAF Operational Viewpoint

## Viewpoint Summary







The Operational Viewpoint provides a logical perspective of the architecture: i.e. it defines (in abstract rather than physical terms) the processes, information and entities needed to fulfil the capability requirements, but does not consider how the solution may manifest itself.

In MODAF the Operational Viewpoint is represented in a series of Operational Views (OVs) that depict organisational entities, processes and information, and the relationships between them, in the context of an Enterprise or Enterprise Phase established in the Strategic Views (StVs).

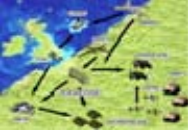
It should be noted that in MODAF the OVs also include some service elements.

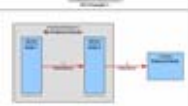
## Views

There are 11 OVs (including sub-views) that make up the Operational Viewpoint:

		<a href="#"><u>An Introduction to OV-1</u></a>	Page 3
1a		<a href="#"><u>OV-1a - High-Level Operational Concept Graphic</u></a> Provides a graphical view of what the architecture is addressing and an idea of the players and operations involved.	Page 4
1b		<a href="#"><u>OV-1b - Operational Concept Description</u></a> Provides a supplementary textual description that explains and details the scenario contained within the associated High Level Operational Concept Graphic (OV-1a) view.	Page 7
1c		<a href="#"><u>OV-1c - Operational Performance Attributes</u></a> Provides detail of the operational performance attributes associated with the scenario / use case represented in the High Level Operating Concept Graphic (OV-1a) and how these might evolve over time.	Page 8
2		<a href="#"><u>OV-2 - Operational Node Relationship Description</u></a> Defines the nodes that provide the focus for the expression of capability requirements within an operational context, and the relationships between them.	Page 10
3		<a href="#"><u>OV-3 - Operational Information Exchange Matrix</u></a> Provides further detail of the interoperability requirements associated with the operational capability of interest.	Page 21
4		<a href="#"><u>OV-4 - Organisational Relationships Chart</u></a> Shows organisational structures and interactions.	Page 24
5		<a href="#"><u>OV-5 - Operational Activity Model</u></a> Describes the activities or processes that are conducted in the course of achieving a mission or a business goal.	Page 28

**An introduction to OV6**

Page 34

6a



**OV-6a - Operational Rules Model**

Page 35

Specifies operational or business rules that constraints how the business is done in the Enterprise.

6b



**OV-6b - Operational State Transition Description**

Page 37

The OV-6b is a graphical method of describing how an node, or activity, changes in response events that affect it.

6c

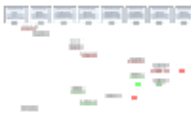

**OV-6c - Operational Event-Trace Description**

Page 39

Provides a time-ordered examination of the information exchanges between participating nodes during a particular scenario.

7



**OV-7 - Information Model**

Page 43

Addresses the information perspective on an operational architecture.

## **Introduction to OV-1a, OV-1b and OV-1c**

The OV-1 provides a high level, scenario-based, description of how a business or military objective might be achieved. It describes a mission<sup>1</sup> or type of mission within the scenario, highlighting the main operational elements and any interesting or unique aspects of the operation.

The OV-1 provides a means of organising the operational architecture models into distinct groups based on scenario context and it communicates the essence of the scenario context in a graphical form supported by textual descriptions, which is ideal for communicating the purpose of the architecture to non-technical stakeholders.

There are three parts to the OV-1:

- OV-1a is the graphic itself.
- OV-1b is a text description providing more detail.
- OV-1c is a tabular representation of key parametric data associated with the scenario (often showing evolution of capability over time). These should reflect the capability requirements.

---

<sup>1</sup> In the MODAF Meta Model (M3), a Mission is defined in quite general terms as a purpose to which resources may be directed.

## **OV-1a - High-Level Operational Concept Graphic**

The OV-1a provides a graphical view of what the architecture is addressing and an idea of the players and operations involved. Its main use is to aid human communication, and it is intended for presentation to high-level decision makers.

### **Background**

The OV-1a provides a graphical, scenario-based, description of a mission<sup>2</sup> or class of mission could fulfil a business objective. It shows the main nodes (see the definition in OV-2, Operational Node Relationship Description) and interesting or unique aspects of operations. It describes the interactions between the subject architecture and its environment (including external systems), in order to convey the right amount of information to stakeholders. Its main utility is to communicate the purpose of the architecture to non-technical, high-level decision makers.

Unlike an OV-2, an OV-1a may show elements of the solution (physical) architecture – in other words, OV-1a is not strictly speaking a logical view.

### **Usage**

- Puts an operational situation or scenario into context.
- Provides a tool for discussion and presentation; for example, aids industry engagement in acquisition.
- Provides an overview of more detailed information in published architectures.

### **Data objects:**

An OV-1a is typically just a graphic, but MODAF allows each symbol in the graphic to be traced back to elements and relationships in the M3. The data to be included in an OV-1a can be any business objects of interest, including:

- Nodes (e.g. headquarters).
- Systems.
- Organisations.
- Information Flows.
- Environmental context objects (e.g. rivers, hills).

### **Representation**

- Graphic.
- Structured graphic.
- UML class diagram (context diagram).
- UML use case.

### **Detailed Product Description**

---

<sup>2</sup> In the MODAF Meta Model (M3), a Mission is defined in quite general terms as a purpose to which resources may be directed.

Each operational view describes one or more Enterprise Phases.

An OV-1a depicts the mission or domain covered by the architecture. In simple terms, an OV-1a will communicate the purpose of architecture is about and provide an idea of the players and operations involved.

The OV-1a provides a graphical executive summary of the architectural endeavour, which describes the interactions between the subject architecture and its environment, and between the architecture and external systems. A textual description accompanying the graphic is essential, with labels on the graphic and a detailed description in the OV-1b. Graphics alone are not sufficient for capturing the necessary architecture data.

The purpose of OV-1a is to provide a quick, high-level description of the business objective that the architecture is addressing, and how that objective might be achieved. An OV-1a can be used to orient and focus detailed discussions. Its main utility is to communicate the purpose of the architecture to non-technical, high-level decision makers.

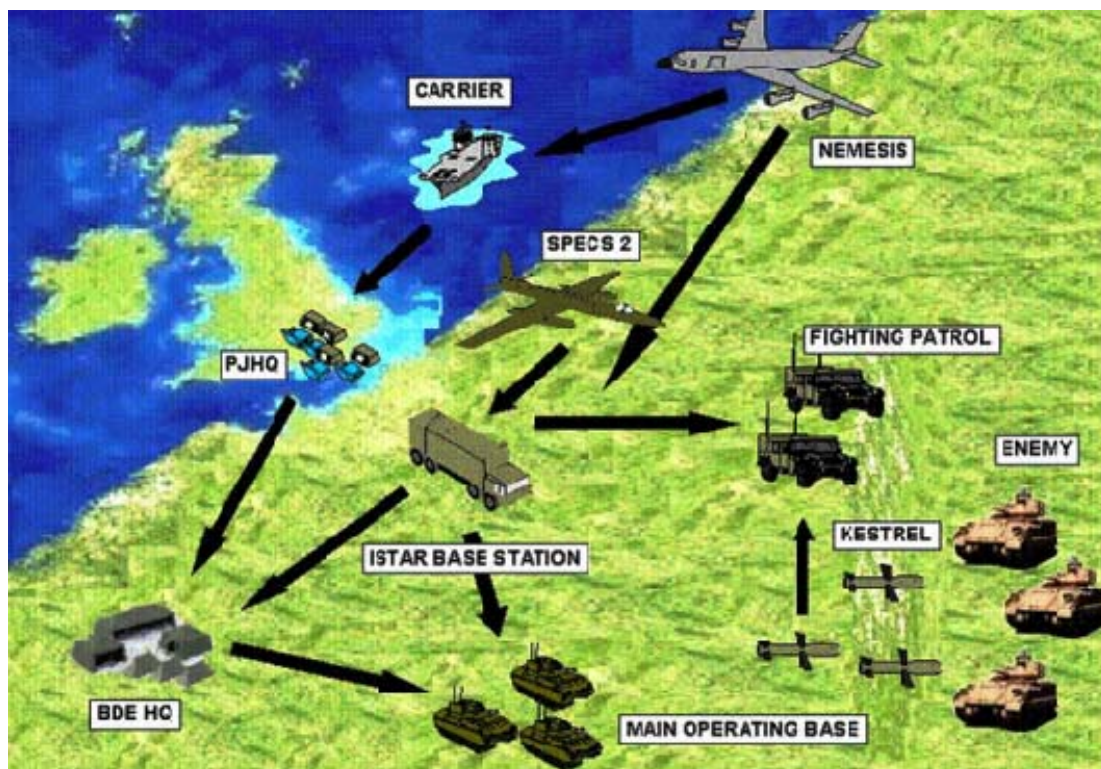

Example OV-1a

The content of an OV-1a depends on the scope and intent of the architecture, but in general it describes the missions, high-level operations, organisations, and geographical distribution of assets. It will provide an overview of the operational concept (what happens, who does what, in what order, to accomplish what goal) and highlight interactions to the environment and other external systems. The content should, however, reflect the executive summary level of the OV-1a, as the other OVs provide the detail of the interactions and sequencing.

In some cases, OV-1a is the last product to be developed, as it conveys summary information about the whole architecture for a given scenario.

OV-1a is the most general of the architectural views and the most flexible in format. Because the format is freeform and variable, no template is shown for this view. An OV-1a product will usually, however, consist of graphics and/or text presented in a form that best communicates the idea of the architecture to the stakeholders.

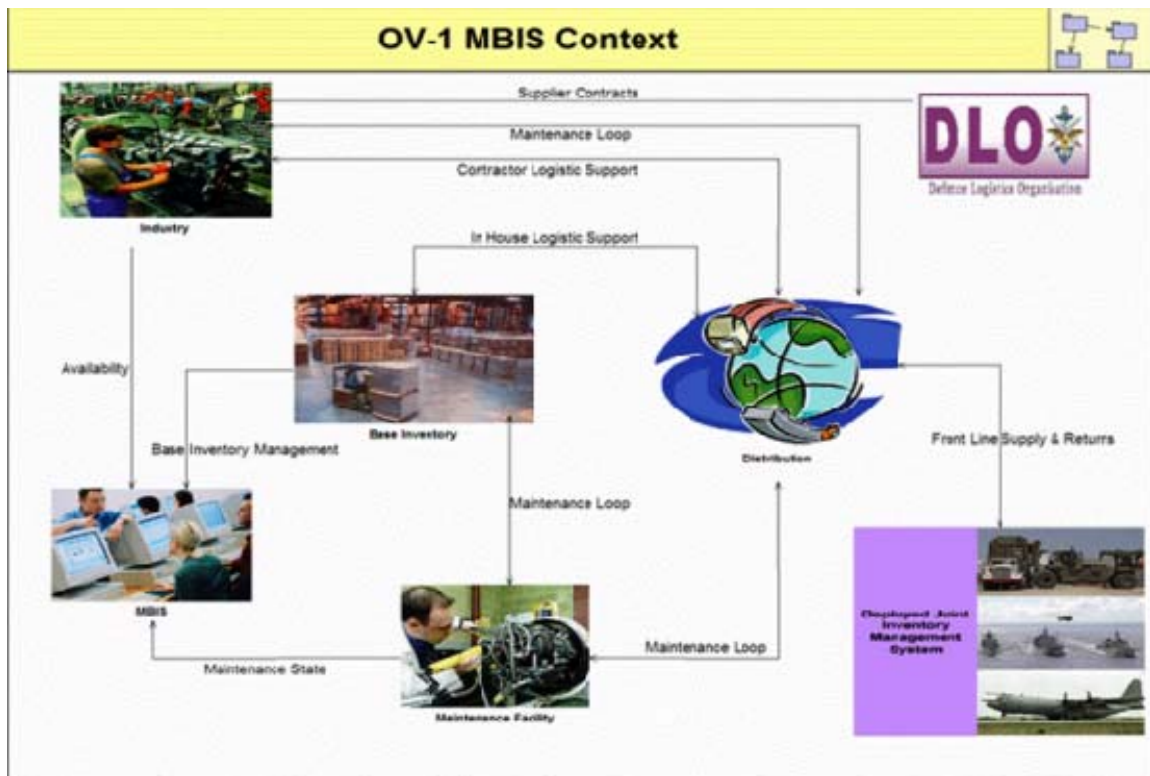

Example OV-1a

From a modelling perspective, the OV-1a view is useful in establishing the context for a suite of related operational views. This context may be in terms of an Enterprise Phase, a time period, a mission and / or a location. In particular, this provides a container for the spatio-temporally constrained performance parameters depicted in OV-1c.

For example, the operational performance metrics for desert warfare in Phase 1 may be different to those in Phase 2. The metrics for jungle warfare in Phase 2 may be different to those for desert warfare in Phase 2.

## **OV-1b Operational Concept Description**

The OV-1b provides a textual description that explains and details the scenario contained within the associated OV-1a, High Level Operational Concept Graphic. The OV-1b should always be developed alongside the associated OV-1a.

### **Background**

An OV-1b product is used to explain and add further detail to the graphical presentation of the scenario shown in the associated OV-1a. It will be developed alongside the OV-1a, and used together they will provide a comprehensive summary of the scenario or use case described within the operational views of the architecture.

### **Usage**

- Concept of operations.
- Input to User Requirements Document (URD).

### **Data objects**

OV-1b is a textual description of the OV-1a graphic so does not usually have specific data objects associated with it.

### **Representation**

- Text.

### **Detailed Product Description**

The Operational Concept Description (OV-1b) View provides a supplementary textual description that explains and details the scenario contained within the associated High Level Operational Concept Graphic (OV-1a) View.

The nature and type of description in an OV-1b product will be very dependant upon the level of detail and maturity in the operational scenario or architecture being described.

Regardless of the method of representation, it is imperative that the information in the view is consistent with the other OVs, and when the OV-1b is updated or modified these changes are cascaded throughout the architecture.

ISTAR information is currently provided by the SPECS system, the LOOKER UAV system and the NEMESIS system. SPECS is an operational level asset and communicates via a data link to its dedicated base station. LOOKER is a tactical UAV system that can transmit real-time video footage directly to either Fighting Patrols or the Brigade HQ. NEMESIS is a strategic asset that has considerable on-board processing capability, enabling the data to be exploited during flight. The resultant information can be communicated either by satellite communications or directly to a receiver based on board a naval vessel.

*Example OV-1b*

## **OV-1c - Operational Performance Attributes**

The OV-1c provides detail of the operational performance attributes associated with the scenario / use case represented in the OV-1a, High Level Operating Concept Graphic, and how these might evolve over time.

### **Background**

An OV-1c Product is used to specify quantifiable attributes and values within the scenario / use case represented in the OV-1a. The values expressed define the performance of specific or multiple capability elements, and can be represented as either single values or a range of values across a defined timescale. The data may indicate changes in particular performance parameters from one Enterprise Phase to the next.

### **Usage**

- Definition of performance characteristics.
- Measures of effectiveness (input to URD).

### **Data objects**

The data in an OV-1c can include:

- Metrics associated with performance associated with specific concepts within the scenario specified within the OV-1a.

### **Representation**

- Tabulation.
- SysML parametric diagram.

### **Detailed Product Description**

The performance of an operational scenario or use case can be measured in a variety of different ways depending upon the scenario context, the capabilities needed to satisfy the requirement and the systems deployed to provide the required capabilities. Possible attributes may include operational tempo, accuracy of targeting, fratricide rate, etc. Furthermore, it may be possible to link the attributes to a specific system or it may only be possible to consider the attributes as an emergent property, for example they are dependent upon all of the elements that are interacting within the scenario, rather than an attribute of the individual elements.

The attributes and values that are specified may be as single values (eg the target engagement process is to be concluded in a maximum time of 25 minutes) or may be used to represent trends or targets that are expected to be achieved. This type of attribute would be represented by a number of values for various points in time or periods of time.

Attribute	Measure	Value			
		As-Is	Period of Time 1	Period of Time 2	Target
Operational Tempo	Rate of advance for an armoured brigade against light resistance	20 km/day	40 km/day	60 km/day	80 km/day
Synchronisation of Effects	Simultaneous rounds on impact delivered by and artillery battery	30 rounds	40 rounds	60 rounds	100 rounds
Sortie rate	Period to refuel and rearm aircraft	4 hours	3 hours	2 hours	1 hour

Example OV-1c

The measurable values that appear in an OV-1c may be performance parameters as shown in the previous example. However, other measurable parameters can be shown as in the following example which refers to sustainability parameters.

Attribute	Measure	2025	2026	2027	2028	2029	2030	Target
SPECS 2 Availability	Number of days down time	45	30	20	18	15	14	10
SPECS 2 Maintainability	Support personnel required to maintain SPECS 2	50	50	45	40	35	34	30
SPECS 2 Reliability	Number of days unplanned down time	10	8	7	6	5	5	5

Example OV-1c

## **OV-2 - Operational Node Relationship Description**

The OV-2 shows, at a high level, the interactions between logical<sup>3</sup> nodes and depicts the capabilities that those nodes bring to the architecture.

### **Background**

The primary purpose of the OV-2 is to specify nodes (elements of capability) in context with each other. The context is usually expressed in terms of the information that flows between the nodes (e.g. the information flow requirements between capabilities in a given scenario). However, the context may also be flows of materiel, human resource or energy.

With MODAF V1.2, the OV-2 has been developed to:

- Adopt a more formal definition of logical flows to represent node connections.
- Support the introduction of Service Oriented Architecture (SOA).
- Accommodate the use of known resources (as defined in SV-1).

### **Usage**

- Definition of operational concepts.
- Elaboration of capability requirements.
- Definition of collaboration needs.
- Associating capability with a location.
- Problem space definition.
- Operational planning.
- Supply chain analysis.
- Security models – e.g. domain-based security and entity trust models.

### **Data objects**

The data in an OV-2 can include:

- Nodes.
- Needlines (bundles of information exchanges).
- Flows of materiel, people or energy.
- Operational Activities.
- Security Domains.
- Trust Lines (for entity trust models).
- Locations ('real' or logical).
- Services.

---

<sup>3</sup> i.e. in abstract rather than physical terms, so as to be solution independent.

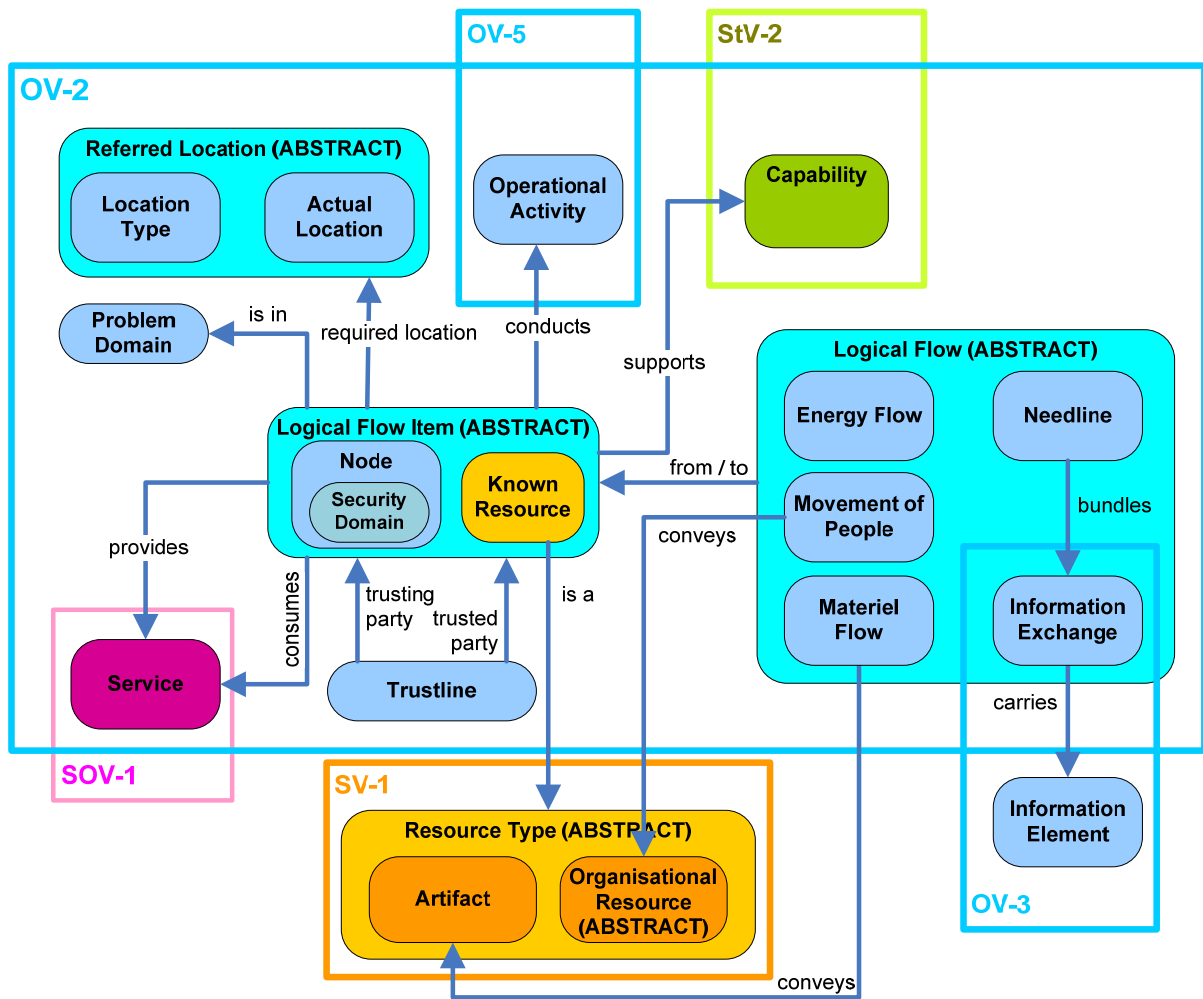

Relationships between Key Data Objects (Simplified from M3)

### Representation

- Topological (connected shapes).
- UML composite structure diagram.

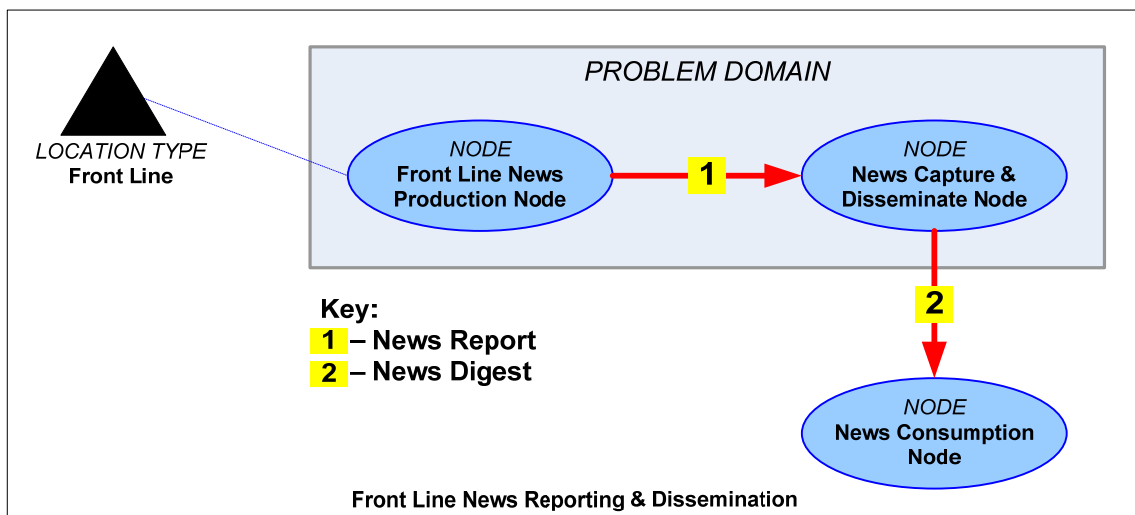

Non-UML OV-2 Example

Structured text may also be used to provide a fuller description of the needlines.

## Detailed Product Description

The OV-2 depicts nodes and the needlines between them, primarily to indicate a need to exchange or share information. The OV-2 may, however, also show the location (or type of location or environment) of nodes, and may optionally be annotated to show flows of people, materiel or energy between nodes.

The primary purpose of an OV-2 is to define the logical structure of architecture. Building on the strategic intent identified in StV-1, Enterprise Vision, OV-2 takes the required capabilities and expresses them as nodes which interact by exchanging information or producing / consuming services.

The nodes in the logical architecture do not represent specific organisations, systems or locations. This enables Information Exchange Requirements (IERS) to be established without prescribing the way that the information exchange is handled. OV-2 does not, therefore, depict the physical connectivity between the nodes. An OV-2 can be a powerful way of expressing the differences between an as-is architecture and a proposed architecture to non-technical stakeholders, as it can be used to emphasise how information flows (or does not flow) without becoming over-complex.

## Nodes

A node is a logical element of capability that may produce, consume, or process information, energy, materiel or people. What constitutes a node can vary among architectures. Here are some examples:

- A logical or functional grouping (e.g. Logistics Node, Intelligence Node).
- The headquarters for an organisation (e.g. Command HQ) or an organisation type (e.g. Joint Task Force HQ).
- A capability or other facility of importance to the business expressed in context of a requirement to interoperate with other capabilities.

Nodes conduct operational activities and, therefore, an OV-2 indicates the key players and the interactions necessary to conduct the corresponding operational activities of an OV-5, Operational Activity Model

## Known Resources

In addition to logical nodes, MODAF allows known resources to be depicted on OV-2s. These resources are defined in SV-1, and are to be used where a constraint on the logical solution exists due to existing resources, such as in a maritime operation where an aircraft carrier is always part of the solution. Known resources shall not be used in a problem domain.

## Needlines

Needlines document the required or actual exchange of information between nodes; they are conduits for one or more information exchanges i.e. they represent a logical bundle of information flows.

A needline does not indicate how the information transfer is implemented. For example, if information produced at Node A is simply routed through Node B and is used at Node C, then Node B would not be shown on the OV-2 diagram – the Needline would go from Node A to Node C. OV-2 is not a communications link or communications network diagram but a high-level definition of the logical requirement for information exchange between elements of capability (nodes).

Needlines are represented by arrows that indicate the direction of flow and are annotated with a diagram-unique identifier and a phrase that is descriptive of the principal type of exchange. It may be convenient to present these phrases in a key to the diagram to prevent cluttering. It is important to note that the arrows (with identifiers) on the diagram represent needlines only. This means that each arrow indicates only that there is a need for some kind of information transfer between the two connected nodes.

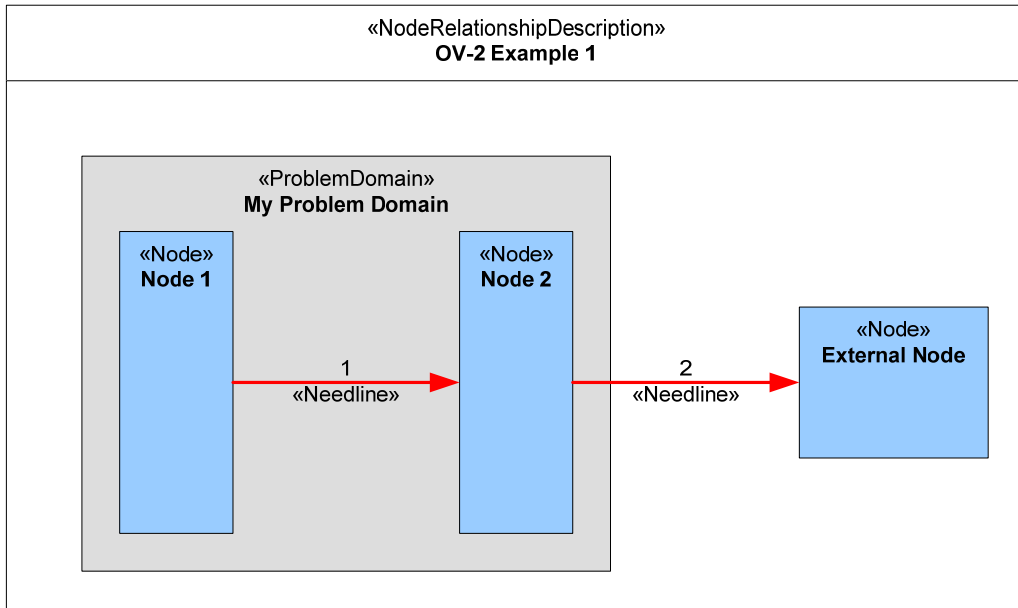

Generic OV-2 showing Needlines

The diagram may include the needline identifiers as numerical labels (as in the example above). Alternatively short phrases may be used.

Because needline identifiers are often needed to provide a trace reference for information exchange requirements (see OV-3), a combined approach with numerical and text labels can be used.

In most cases there will be only one needline between any two nodes (which may carry multiple information exchanges). This is not mandatory, however, and the architect may choose to group the exchanges into more than one needline.

There is a one-to-many relationship from needlines to information exchanges (e.g. a single needline in OV-2 represents multiple individual information exchanges). The mapping of the exchanges to the needlines of OV-2 occurs in the OV-3, Operational Information Exchange Matrix. For example, an OV-2 may have a needline labelled “Situation Report” which represents a number of information exchanges, consisting of various types of reports (information elements), and their attributes (such as periodicity and timeliness). The identity of the individual elements and their attributes are documented in OV-3, along with the producing and consuming activities from OV-5, Operational Activity Model.

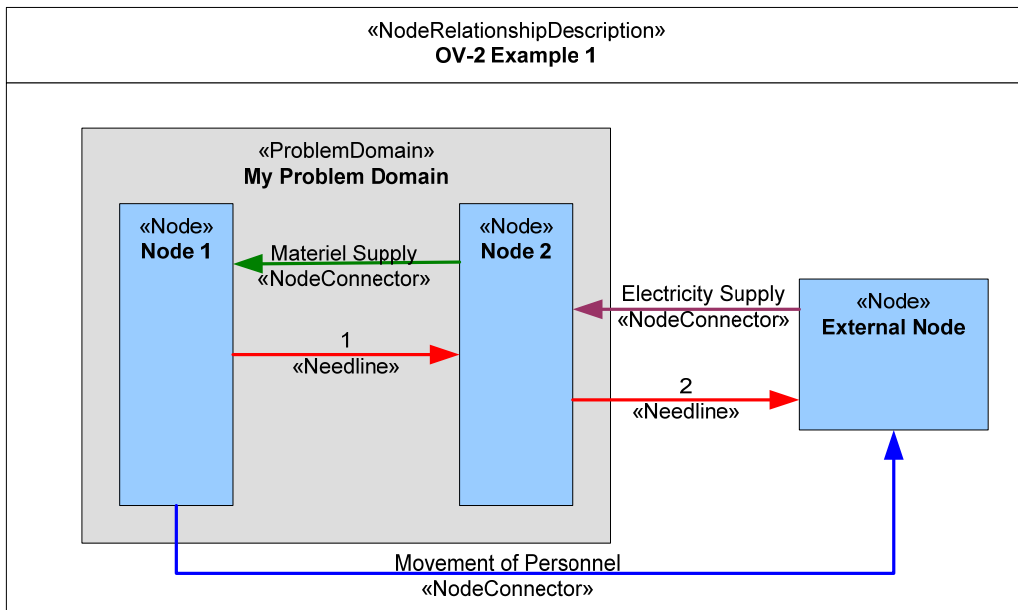

Generic OV-2 showing Needlines and Flows

### Nesting of Nodes

It is often convenient to model nodes as being nested, in other words one node is part of another. A simple example is shown below.

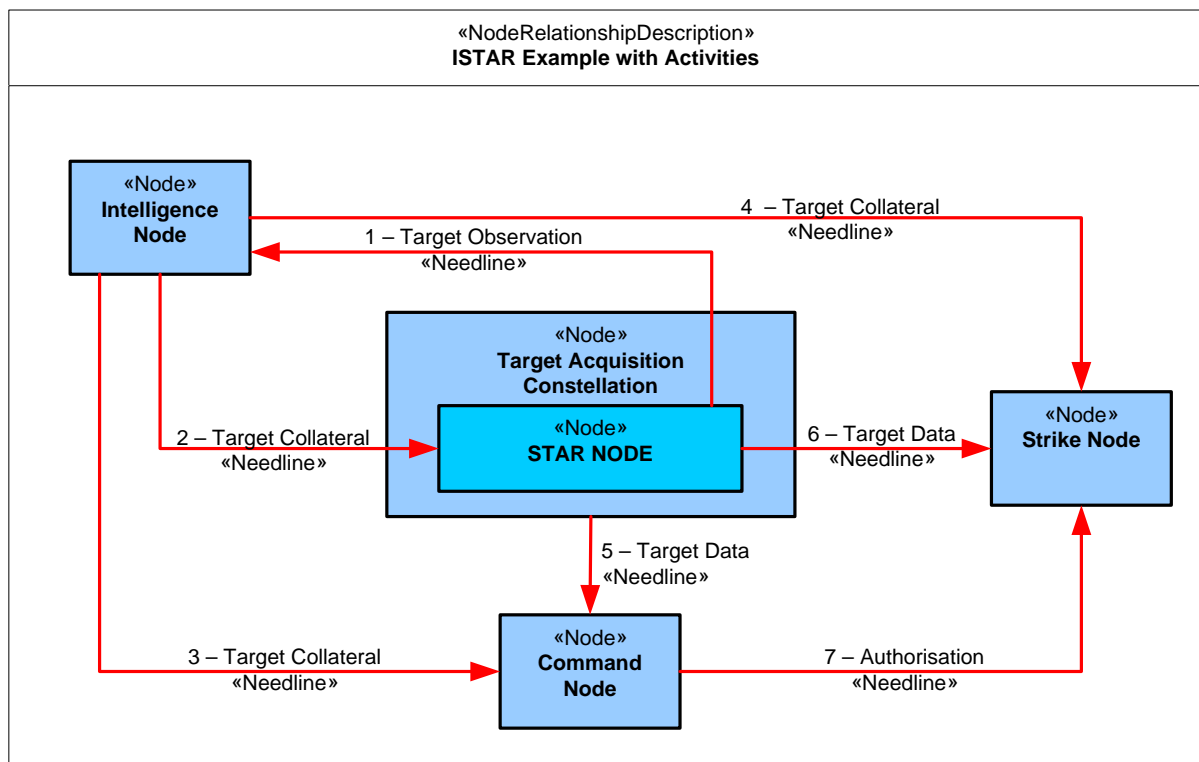

Example OV-2 with nested Nodes

This technique may be used to include the same node more than once on the diagram. This works because each occurrence of the node has a different usage context. Care should be taken when using nested nodes, particularly when OV-2 is being used to express a user requirement. Nesting nodes would imply a structure on the solution architecture and so could close off some avenues of innovation.

Nesting is also sometimes used to show 'roles' associated with each node (often together with the activities those roles perform). It is important that the OV-2 logical view maintains focus on the operational requirements and avoids 'solutioneering'. The 'roles' that may feature on an OV-2 are used as a convenient means to compartmentalise the logical architecture. A legitimate example of this is the use of an OV-2 to depict a generic set of functional cells within a generic headquarters (such as a Land Battlegroup HQ). The capability required of each functional cell may be delivered by people alone or through a combination of systems and people (see capability configurations within SV-1).

### **Trade-Space and Requirements**

The OV-2 may also represent operational concepts that are of critical importance to requirements definition. In OV-2 this is achieved by mapping capabilities onto nodes to represent the required level of capability in the architecture. The requirements specified in this way may then be realised by more than one suite of SVs; i.e. there may be multiple potential specifications that can be traded off against each other.

The OV-2 can also describe the trade-space by using an M3 concept called Problem Domain. Those nodes that are within the problem domain are those expected to be delivered in the solution. Those outside the problem domain are not part of the solution but represent external elements the solution will be expected to interact with. This is important for several reasons:

- A User Requirements Document is intended to define a bounded operational capability and it is therefore helpful to reflect this in any operational architecture models that provide context for those requirements.
- It is essential to model capabilities outside the boundary to be able identify dependencies so that interoperability requirements can be modelled (in terms of collaboration across the boundary), and external constraints can be highlighted. The definition of boundary provides focus for several other views (e.g. OV-3, Operational Information Exchange Matrix, and SV-2, Systems Communications Description).

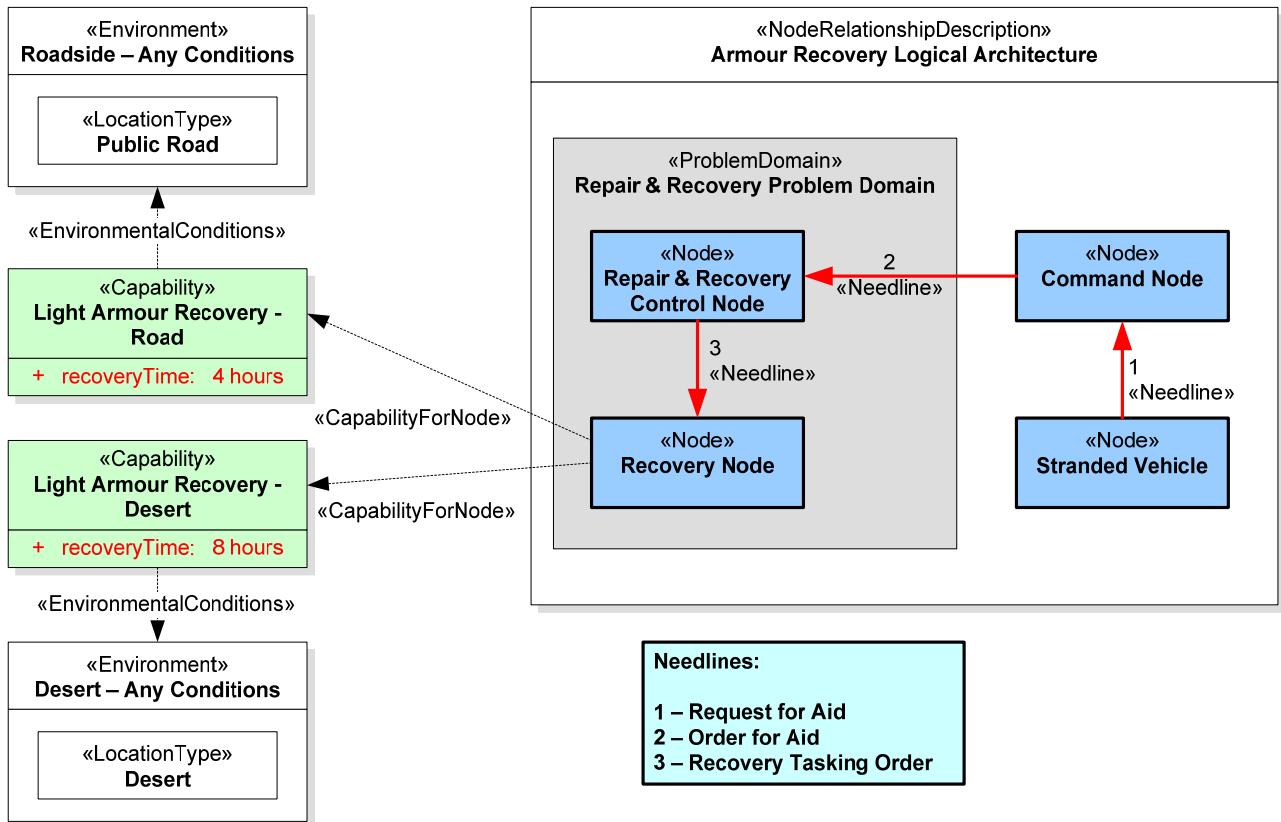

OV-2 showing Problem Domain

A node can be realised by a resource or combination of resources (specified in SV-1).

### Operational Activities

The operational activities (from the OV-5, Operational Activity Model) performed by a given node may be listed on the graphic, if space permits. OV-2 and OV-5 are complementary descriptions. OV-2 focuses on the nodes, with the activities being a secondary adornment. OV-5, on the other hand, places first-order attention on operational activities and only second-order attention on nodes, which can be shown as annotations or swim-lanes on the activities. In developing a logical architecture, OV-2 and OV-5 are often the starting points and these may be developed iteratively.

Examples of how this can be depicted are illustrated in following diagrams on the following pages.

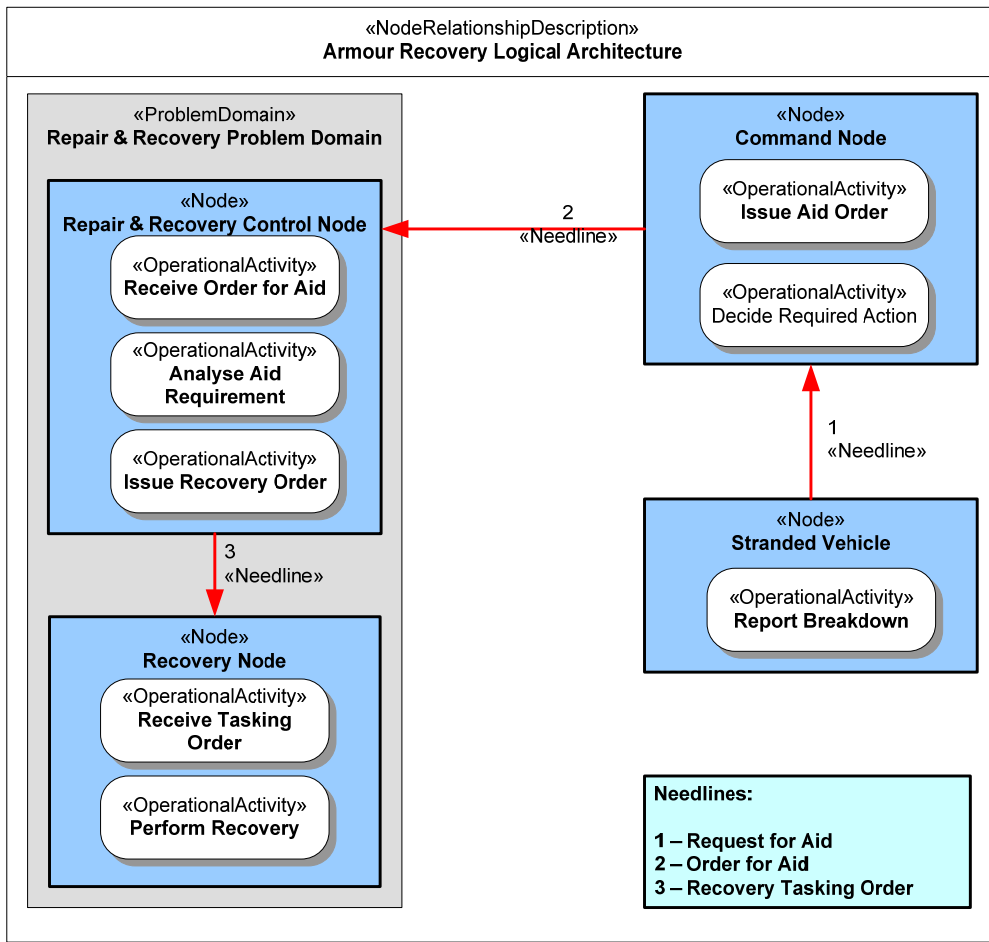

OV-2 showing Nodes having Operational Activities

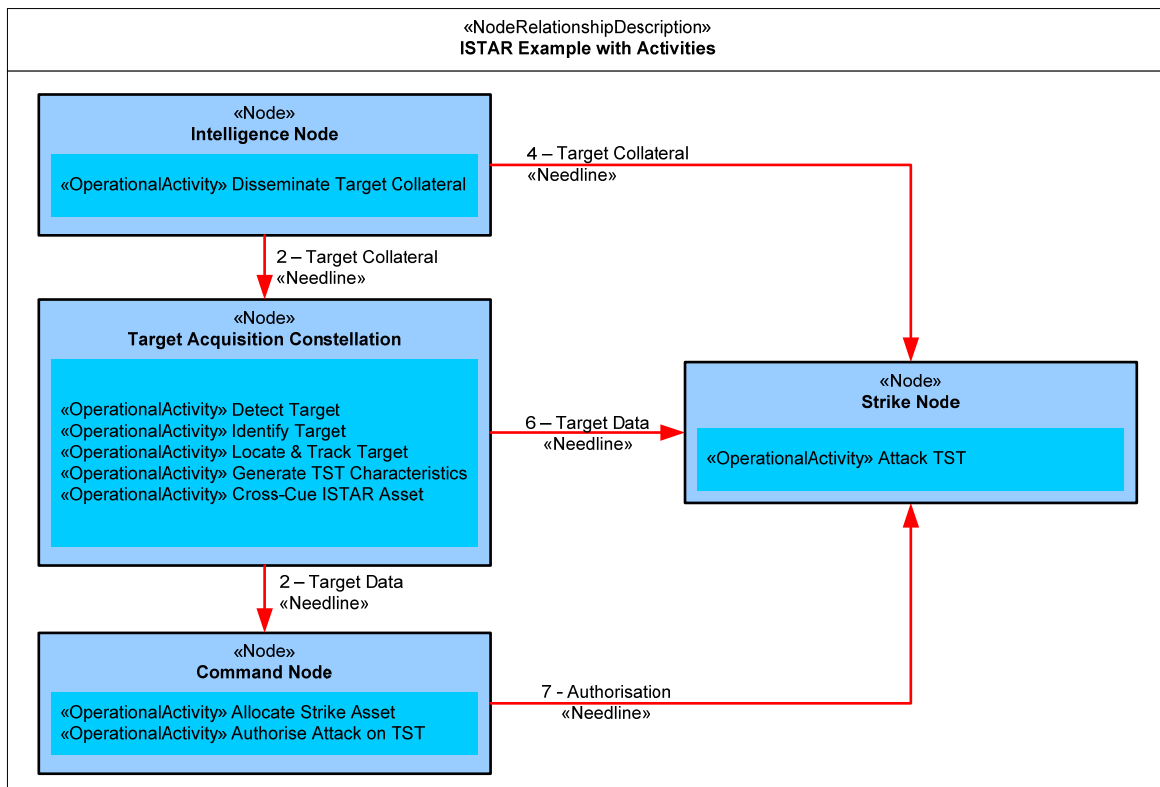

OV-2 showing Nodes having Operational Activities

## Locations

An OV-2 can also show the location of each node, if the location is known or knowable. The location may be specified geographically, and this in turn may be a specific geographic location (eg "RAF Wyton") or a type of location or environment (eg "behind enemy lines").

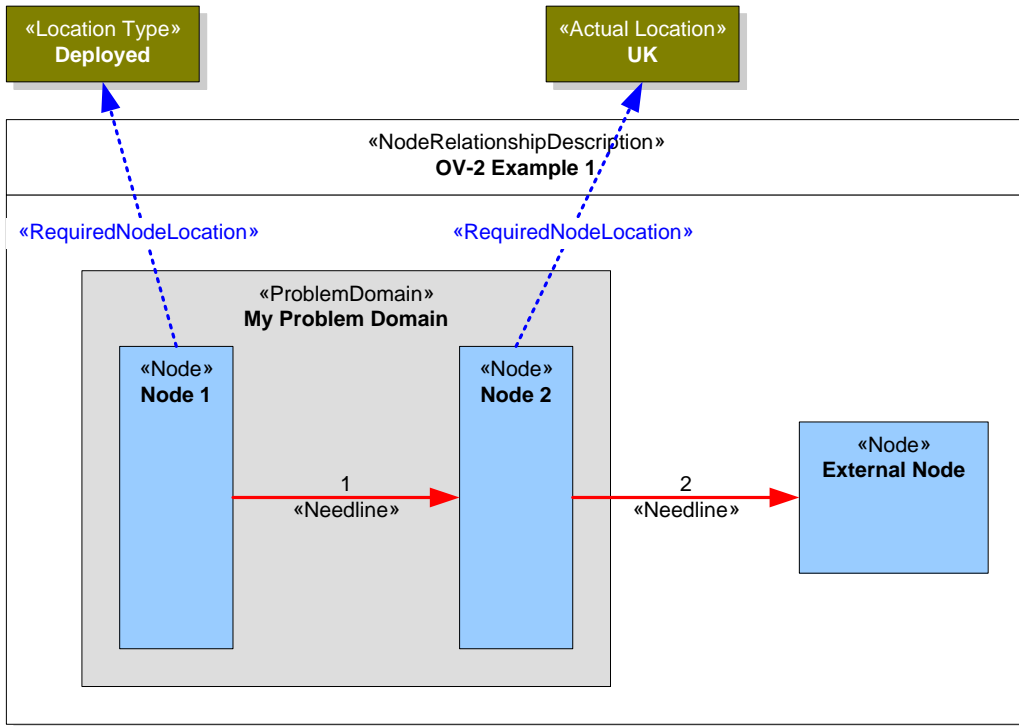

Generic OV-2 with locations

## Service Oriented Architectures

If the architect is developing a Service Oriented Architecture (SOA), an OV-2 may be used to show which logical agents (nodes) produce and consume services. The concept of producing and consuming services replaces the idea of fixed needlines – loose coupling is a tenet of SOA.

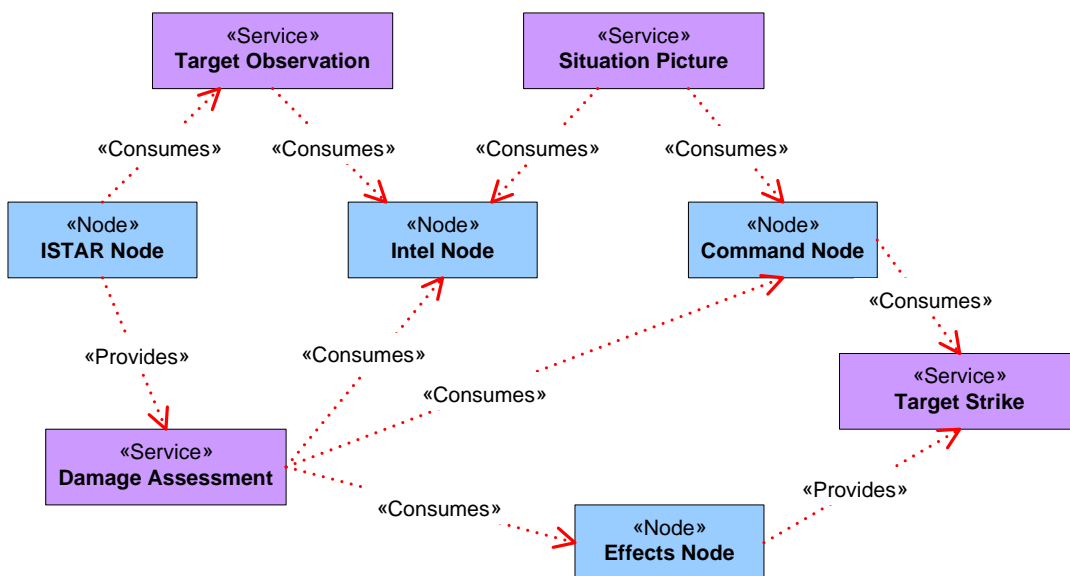

OV-2 showing Service Elements

As with a non-SOA OV-2, the capabilities of the nodes may also be shown. Most architectures are likely to consist of point-to-point connections as well as service interactions, so it is possible to have OV-2 products which combine the neckline and service approach:

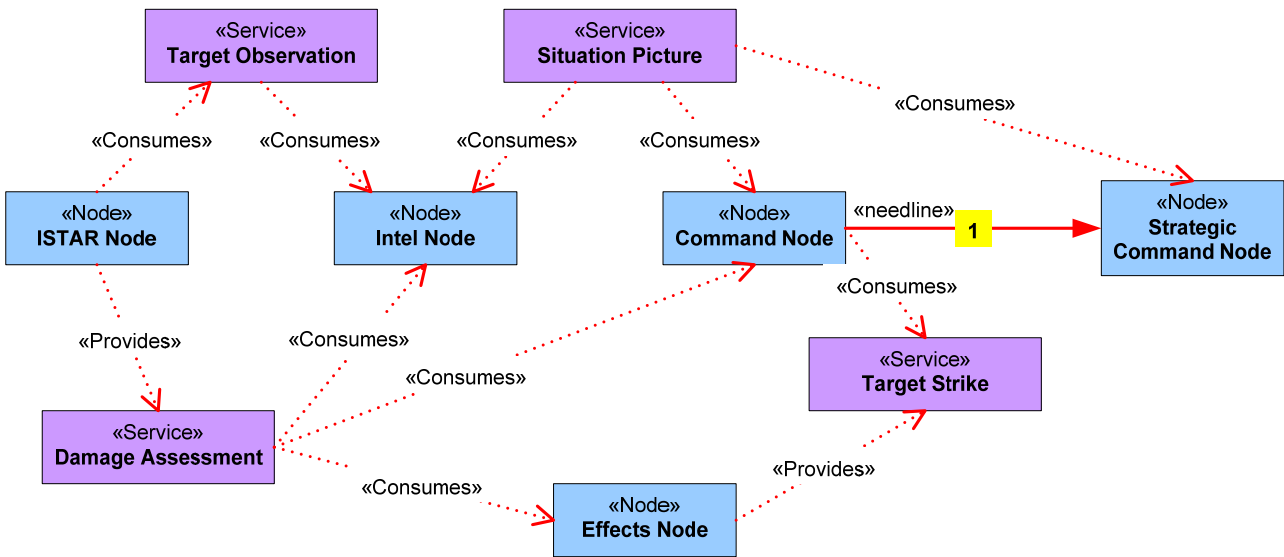

OV-2 showing Service Elements with traditional needlines

### Security Models in OV-2

An OV-2 may also be used to model certain aspects of security. In particular, security domains may be shown, which can be used to assert a common security policy over a number of nodes or known resources:

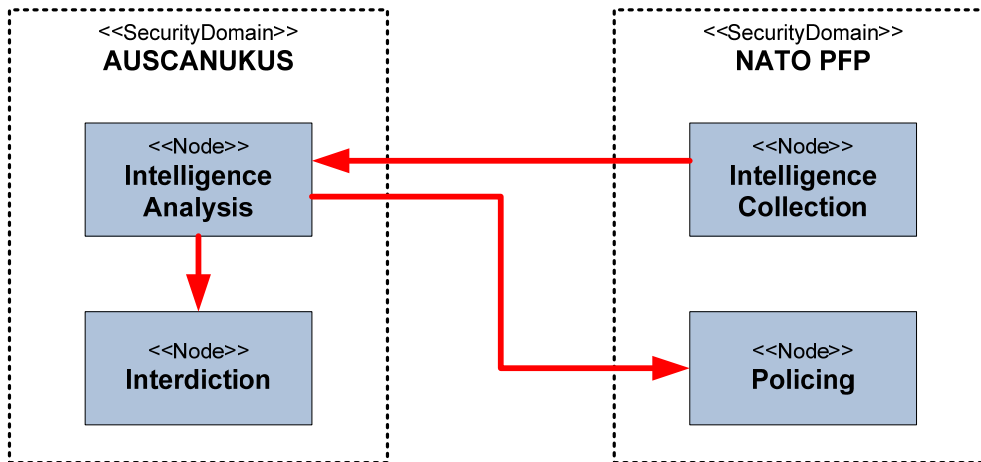

OV-2 showing needlines between nodes belonging to different security domains

As well as showing security domains, OV-2 may also be used to specify entity trust relationships between nodes and known resources. The trust is shown as a line between the nodes or resources, specifying a numeric level of trust. The arrow of the trust line points to the trusted party, and the number indicates how much that party is trusted by the party at the non-arrow end. MODAF does not specify a scale of trust, and the numeric values used may be different for each architecture, and policy should be outlined as to what nature of information (e.g. protective marking) may be

shared along trust lines assigned those values. Note that this mechanism allows for cases where mutual trust differs – e.g. party A trusts party B more than B trusts A.

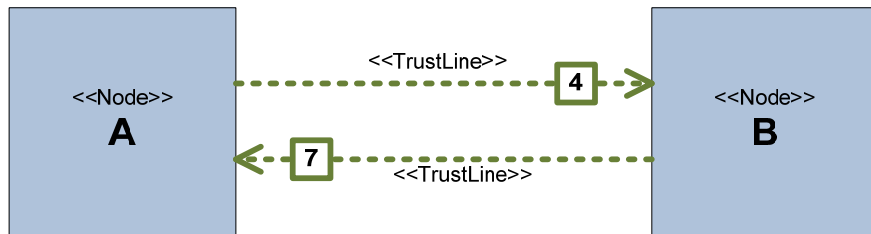

*OV-2 excerpt showing trust lines between nodes*

Trust lines may also be specified between security domains – meaning that every element inside one domain trusts every element in the other domain to a given level.

## OV-3 - Operational Information Exchange Matrix

The OV-3 details the operational information exchanges between nodes, as defined in the OV-2, Operational Node Relationship Diagram.

### Background

Information exchanges help define the interoperability requirements associated with the operational capability of interest. Although the primary purpose of this view is to specify information exchanges, an OV-3 may also list flows of materiel, energy and human resources.

### Usage

- Definition of interoperability requirements.

### Data objects

The data in an OV-3 can include:

- Information Exchanges (each associated with a needline).
- Information Elements (each carried by one or more information exchange).
- Operational Activities (that produce and consume the information elements).
- Nodes (between which the information exchanges take place).

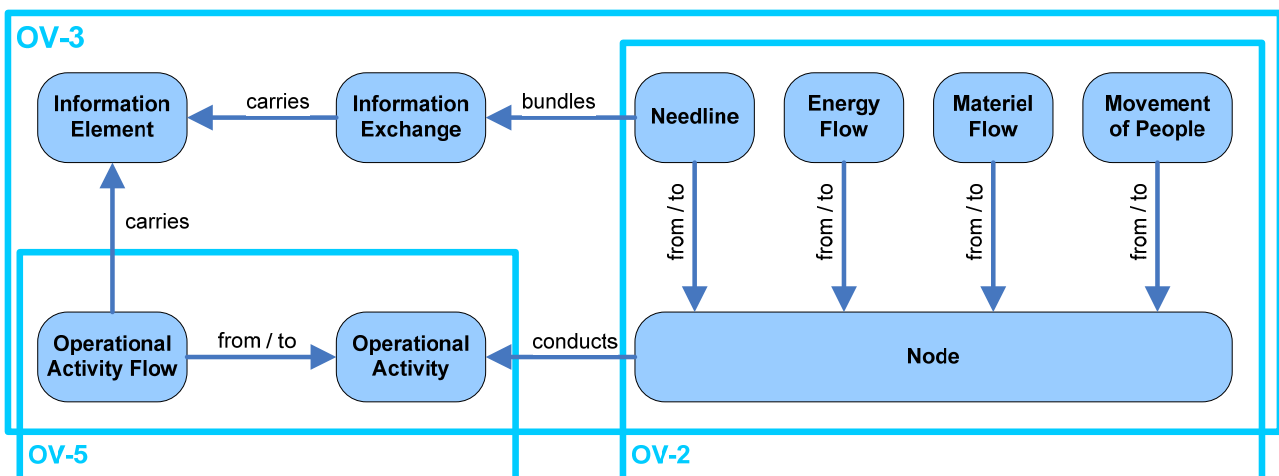

*Relationships between Key Data Objects (Simplified from M3)*

### Representation

- Tabulation.

### Detailed Product Description

The OV-3, Operational Information Exchange Matrix, identifies the information transfers that are necessary to enable the nodes to achieve a business objective. This view is initially constructed from the information contained in OV-2, Operational Node Relationship Description, and OV-5, Operational Activity Model; however, OV-3 provides a more detailed definition of the information flows between nodes.

The Operational Information Exchange Matrix details information exchanges by identifying which nodes exchange what information, with whom, why the information is necessary, and the key attributes of the associated information products. Information exchanges express the relationship across the three main M3 elements for the

Need-line	Info Exchange	From Node	To Node	Media	Security Classification	Estimated Data Rate	Info Element
1	1	Node1	Node2	Imagery	UNCLAS	2 Mbs <sup>-1</sup>	Info Element1
1	2	Node1	Node2	Voice	SECRET	N/A	Info Element2
2	3	Node2	External Node	Imagery	UNCLAS	2 Mbs <sup>-1</sup>	Info Element1

*An example OV-3*

Operational Viewpoint (operational activities, nodes, and information flows) with a focus on the specific aspects of the information flow and the information content. OV-3 is one of a suite of operational views that address the information content of the operational architecture (the others being OV-2, Operational Node Relationship Diagram, OV-5, Operational Activity Model, and OV-7, Information Model).

The OV-3 maps information elements to the producing and consuming nodes, the needlines between them, and the activities that they support.

An information element is a piece of information that is subject to an operational process. The structure of the information element may be defined by a logical data model (see OV-7, Information Model). Information elements are carried on operation activity information flows (in OV-5) and information exchanges (in OV-2). The same information element may be used in one or more information exchanges.

An architect may specify attributes for the Information exchanges in OV-3. Typical attributes would be “timeliness”, “availability”, “protective marking”, “non-repudiation”, etc.

Multiple information exchanges may be bundled into one needline. In OV-3, this information is captured in tabular form, usually with the needline identifier being shown in one of the columns.

The column headings in an OV-3 matrix are not prescribed by MODAF, this allows the architect to select the most appropriate headings for a given architecture. Most OV-3 tables will at least have columns for:

- Information Exchange ID.
- Producing Node.
- Consuming Node.
- Needline ID.
- Producing Activity.
- Consuming Activity.

A more complex example of an OV-3 is shown on the next page.

The emphasis in this view is on the logical and operational characteristics of the information being exchanged. It is important to note that OV-3 is not intended to be an exhaustive listing of all the details contained in every information exchange of every node associated with the architecture in question. Rather, this product is intended to capture the most important aspects of selected information exchanges.

Needline Identifier	Information Exchange Identifier	Information Element Description					Producer		Consumer		Nature of Transaction				
		Information Element Name and Identifier	Content	Scope	Accuracy	Language	Sending Operational Node Name and Identifier	Sending Operational Activity Name and Identifier	Receiving Operational Node Name and Identifier	Receiving Operational Activity name and Identifier	Mission / Scenario UJTL or METL	Transaction Type	Triggering Event	Interoperability Level Required	Criticality
1	WOC-JFAC C1	BDA Report	Report on Battle Damage	Theatre	1 Day	English	WOC	Conduct Battle Damage Assessment	JFACC	Conduct Munitions Effects Assessments	Combat Assessment	Collaborative	AirStrike 072200, 0615	2A	High
1	WOC JFAC C2	Target Nominations	Report on Possible Targets	Theatre	2 Hours	English	WOC	Recommend Airstrike	JFACC	Request Target Materials	Combat Assessment	Direct	AitTO XX, 072300	1B	High
2															
...															
11	MAW JFAC C1	BDA Report	Report on Battle Damage	Theatre	1 Day	English	MAW	Conduct Battle Damage Assessment	JFACC	Conduct Munitions Effects Assessments	Combat Assessment	Collaborative	AirStrike 072200, 0615	2A	High

More Complex OV-3 Example

## **OV-4 - Organisational Relationships Chart**

The OV-4 shows organisational structures and interactions. OV-4 exists in two forms: typical (e.g. a generic brigade command structure) and actual (e.g. an organisation chart for a department or agency).

### **Background**

A **typical** OV-4 shows the possible relationships between organisational resources (organisations and posts); the key relationship being the composition; i.e. how organisational resources are structured within a parent organisation. It may also show the posts in an organisation and the roles<sup>4</sup> associated with each post. Interactions may be specified between organisational resources (organisations, posts and roles), which may be command relationships. Interactions typically illustrate the fundamental roles and management responsibilities. A **typical** OV-4 can be considered as a special type of SV-1, Resource Interaction Specification, where the resources shown are purely organisational.

An **actual** OV-4 shows the structure of a real organisation at a particular point in time, and is used to provide context to other parts of the architecture such as AV-1, (Architecture) Overview and Summary and the StVs.

### **Usage**

A **typical** OV-4 may be used for:

- Organisational analysis.
- Definition of human roles.
- Operational analysis.

An **actual** OV-4 may be used to:

- Identify process owners.
- Illustrate current or future organisation structures.

### **Data objects**

The data in an OV-4 can include:

- Organisation types.
- Resource composition relationships.
- Resource interaction relationships.
- Post types.
- Role types.
- Actual posts and organisations.
- Competences.

---

<sup>4</sup> The roles represent the functional aspects of organisational resources.

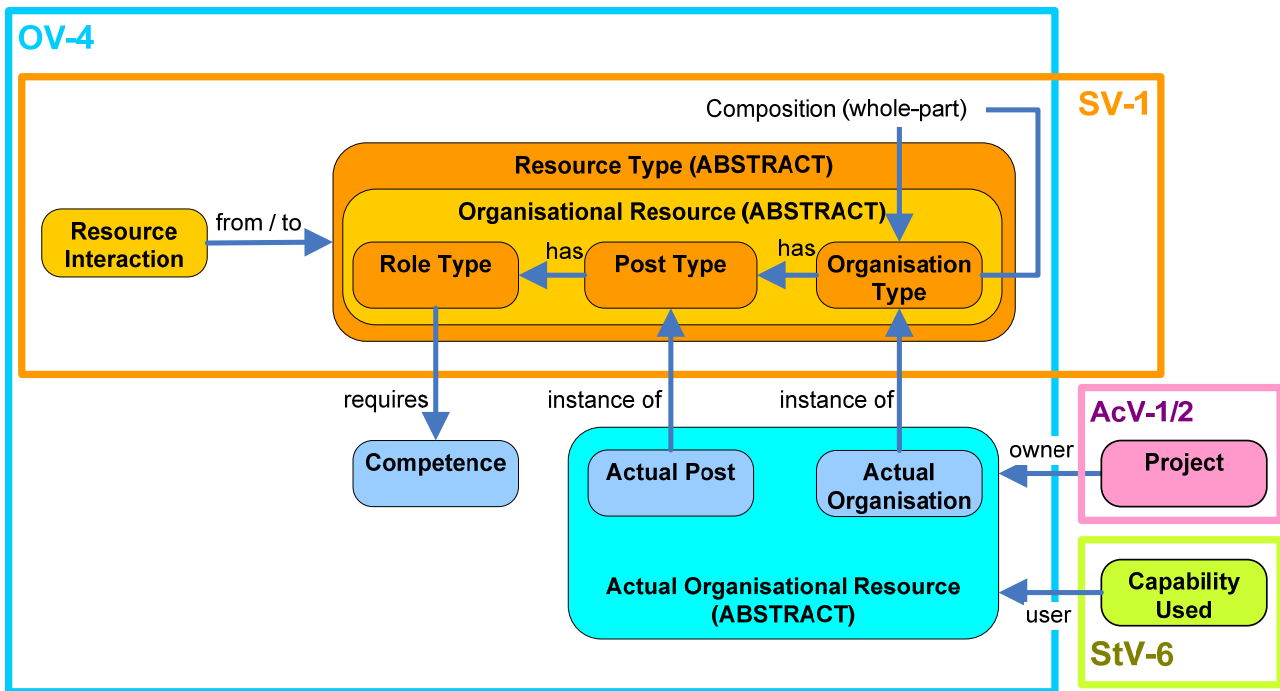

Relationships between Key Data Objects (Simplified from M3)

## Representation

- Graphical.
- UML composite structure diagram (**typical**).
- UML instances (**actual**).

## Detailed OV-4 Product Description

The OV-4, Organisational Relationships Chart, addresses the organisational aspects of an architecture.

A **typical** OV-4 illustrates the command structure or relationships (as opposed to relationships within a business process flow) among human roles, organisations, or organisation types that are the key players in the business represented by the architecture.

An **actual** OV-4 shows real organisations and posts and the relationships between them.

MODAF only defines two fundamental relationships between Organisational Resources: structure (whole-part) and interaction (which includes the command relationship). When there is a need for other types of organisational relationships, these should be recorded and defined in the AV-2, Integrated Dictionary.

An OV-4 clarifies the various relationships that can exist between organisations and sub-organisations within the Architecture and between internal and external organisations.

Note that individual people are not modelled in MODAF, but specific posts may be detailed in an **actual** OV-4.

A **typical** OV-4 product may show types of organisations and the typical structure of those organizations:

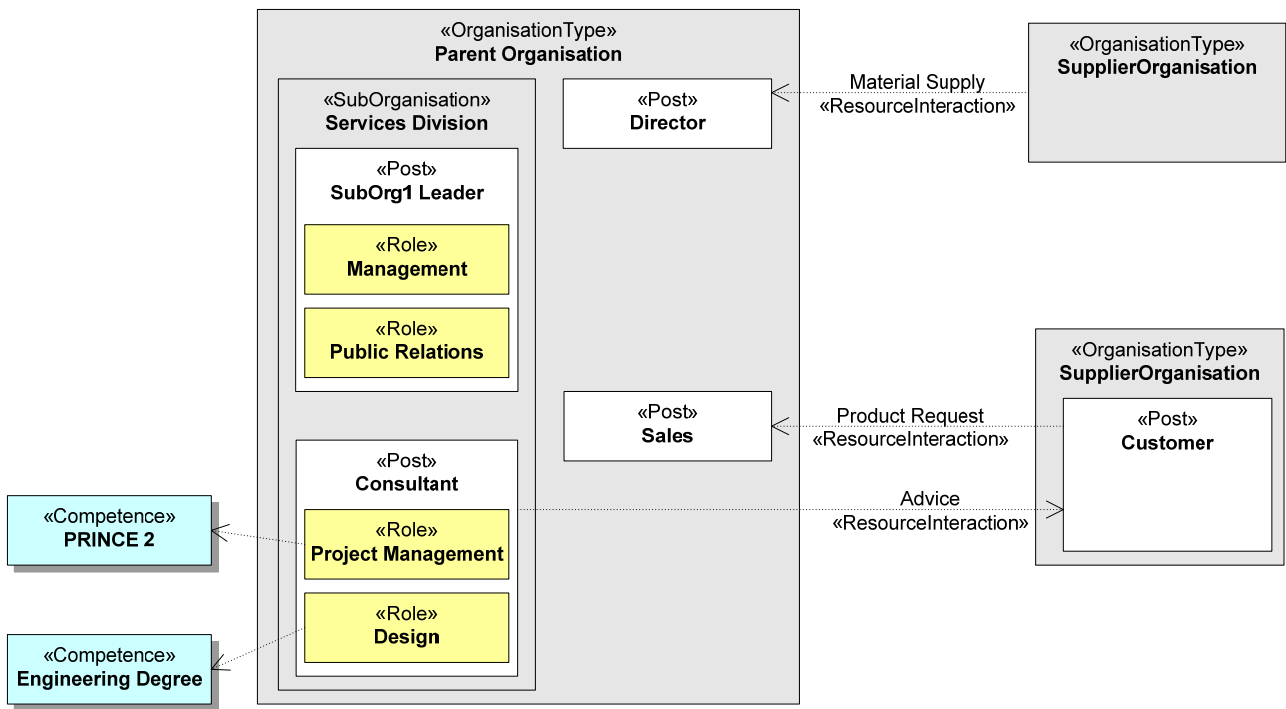

OV-4 Example

OV-4 products may alternatively show actual, specific organisations (eg “The UK Ministry of Defence Head Office”) at some point in time:

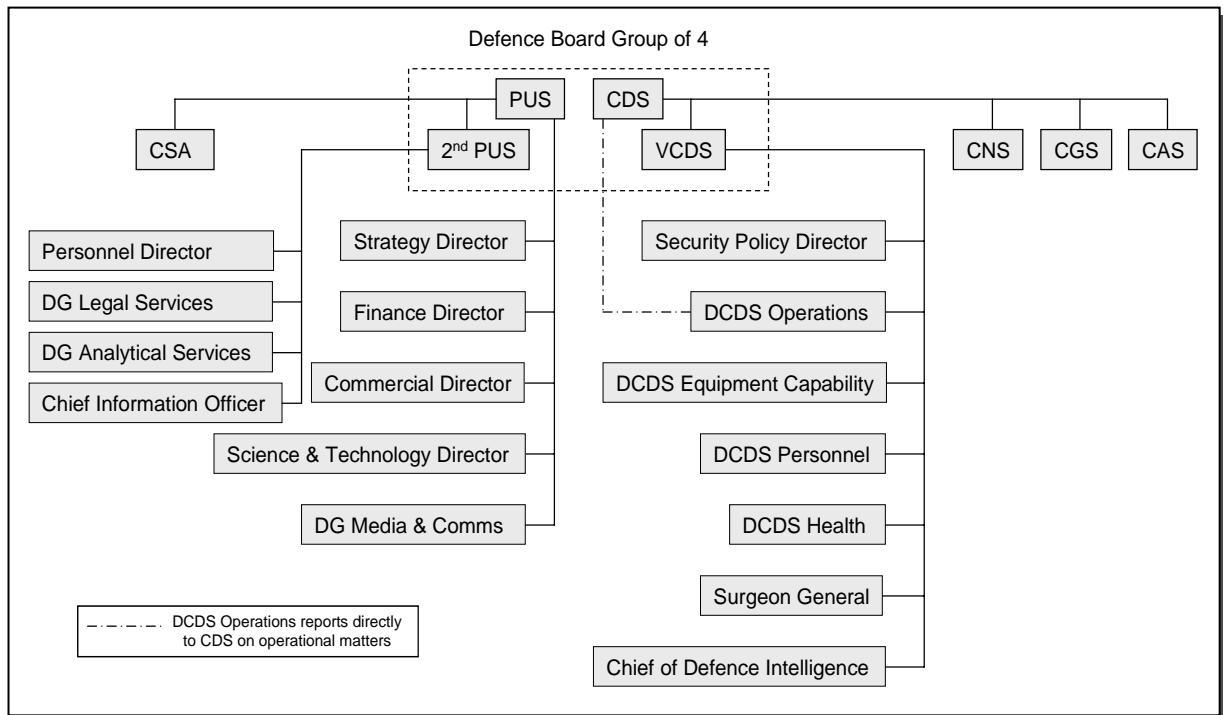

OV-4 Example

(Source: MOD Management Framework)

Alternatively, an OV-4 may be a hybrid diagram showing **typical** and **actual** organisation structures:

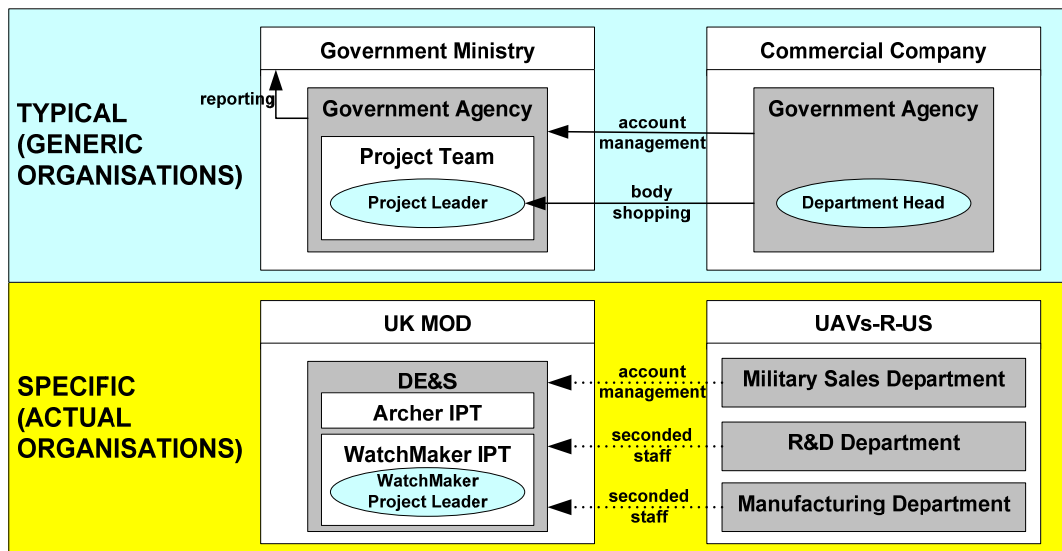

OV-4 Example

In both the **typical** and **actual** cases, it is possible to overlay resource interaction relationships which denote relationships between organisational elements that are not strictly hierarchical (e.g. a customer-supplier relationship).

In an SV-1, Resource Interaction Specification, the organisational resources defined in a **typical** OV-4 may be part of a capability configuration. Also, **actual** organisations may form elements of a fielded capability which realises the requirements of a node at the system level (again, this may be depicted on an SV-1).

The organisational resources depicted in an OV-4 (typical) may perform functions (SV-4). An OV-4 (actual) may depict operational activities (OV-5) and enduring tasks (StV-1), but only to show ownership of processes.

Roles may require certain competences and this should be modelled where applicable.

The organisations and types of organisation that are modelled using OV-4 in the Operational Viewpoint may also appear in other views, for example SV-1 (organisational constituents of a capability configuration) and AcV-1 (actual organisations that own projects).

## **OV-5 - Operational Activity Model**

The OV-5 describes the activities that are conducted in the course of achieving a mission or a business goal. It describes operational activities, the flows (inputs and outputs) between activities and may optionally show the nodes that conduct the activities.

### **Background**

OV-5 describes the operational activities (or business processes) that are being conducted within the mission or scenario.

OV-5 activity models describe the business processes associated with the architecture, as well as the:

- Relationships or dependencies among the business processes.
- Information exchanged between business processes.
- External interchanges (from/to business processes that are outside the scope of the model).

An operational activity is a logical process, specified independently of how it is carried out. To maintain this independence from implementation, logical nodes in OV-2, Operational Node Relationship Description, are used to represent the structure which carries out the operational activities. Operational activities are realised as functions in the SV-4, Functionality Description; i.e. the OV-5 describes that “what” which is mapped to the SV-4 that defines the “how”.

In the Operational Viewpoint, the OV-5 complements the OV-2. OV-2 focuses on the nodes, and the OV-5 focuses on the operational activities undertaken by those nodes. Consequently, the OV-2 and OV5 are usually developed together in an iterative fashion.

### **Usage**

- Requirements capture (input to URD).
- Description of business processes and workflows.
- Operational planning.
- Logistic support analysis.
- Information flow analysis.
- Support task analysis to determine training needs.

### **Data objects**

The data in an OV-5 can include:

- Operational activities.
- Standard operational activities (originating in StV-6).
- Operational Activity Flow Objects
- ‘Swimlanes’ (each associated with a node).

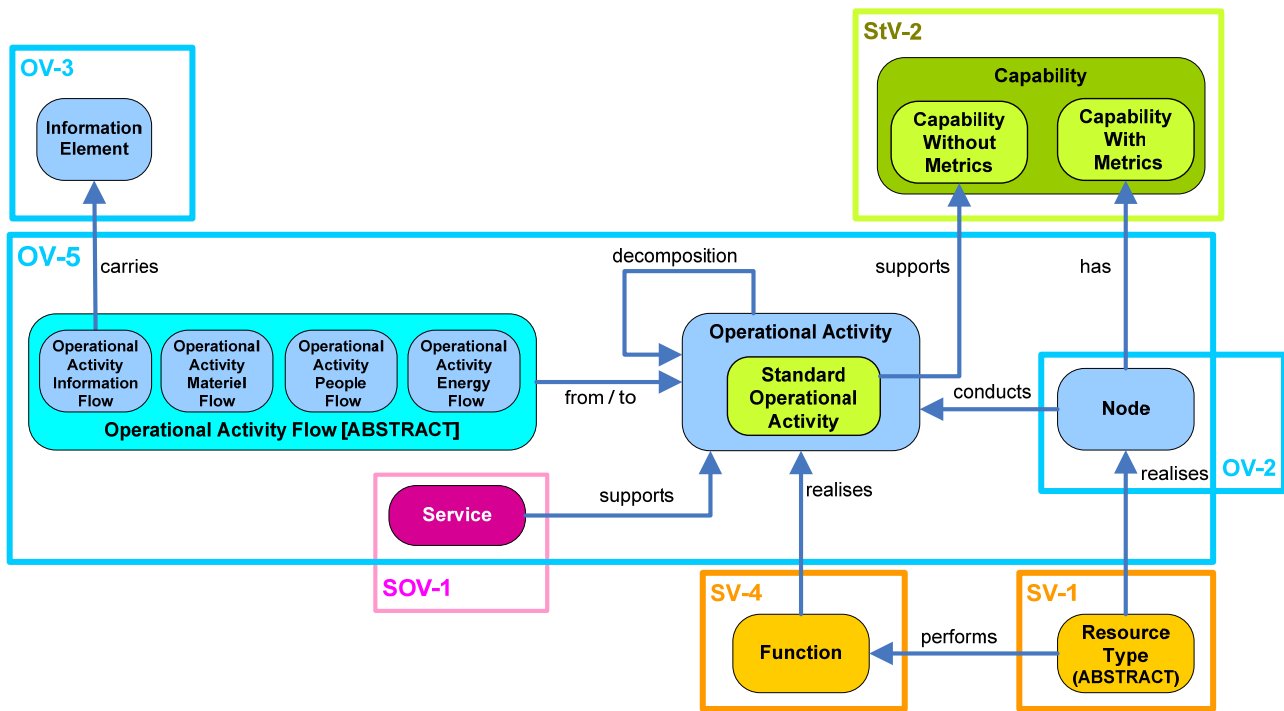

Relationships between Key Data Objects (Simplified from M3)

## Representation

- Hierarchy chart.
- IDEF0 activity model.
- BPMN diagram.
- UML activity diagram.
- UML activity diagram (with swimlanes).

## Detailed Product Description

The OV-5 describes the activities that are normally conducted in the course of achieving a mission or a business goal. It describes operational activities (or business processes) and the input and output flows between those activities.

The activities described in an OV-5 may be standard operational activities which are defined in StV-6, Standard Operational Activities to Capability Mapping. Standard operational activities are those defined in doctrine, but which are not tailored to a specific requirement, i.e. they may be used across multiple logical architectures.

There are two basic ways to depict activity models:

- The activity hierarchy shows activities depicted in a tree structure and is typically used to provide a navigation aid.
- The activity flow diagram shows activities connected by information flow arrows.

The OV-5 activity hierarchy chart helps provide an overall picture of the activities involved and a quick reference for navigating the OV-5 input/output flow model.



Example OV-5 Activity Hierarchy

The OV-5 activity flow diagram shows activities related by flows. Input / outputs of operational activities relate to information elements of OV-3, Operational Information Exchange Matrix, and are further characterised by the information exchange attributes described in OV-3. The information elements may be further described using OV-7, Information Model.

The operational activities in an OV-5 are undertaken by nodes from the corresponding OV-2. Consequently, the level of detail and decomposition in the OV-5 will be aligned with the complexity of the relationship of the nodes in the OV-2.

Operational activities may consume or produce information. When these cross node boundaries they are carried by information exchanges shown in the OV-2. In this way an OV-5 can contribute to IER analysis.

Annotations to the activities may also identify the costs (actual or estimated) associated with performing each activity.

The business rules that govern the performance of the activities can be keyed to each activity - the business rules may be described in OV-6a, Operational Rules Model.

In addition, a process flow model may be annotated with the names of the nodes responsible for conducting those activities, in swimlanes.

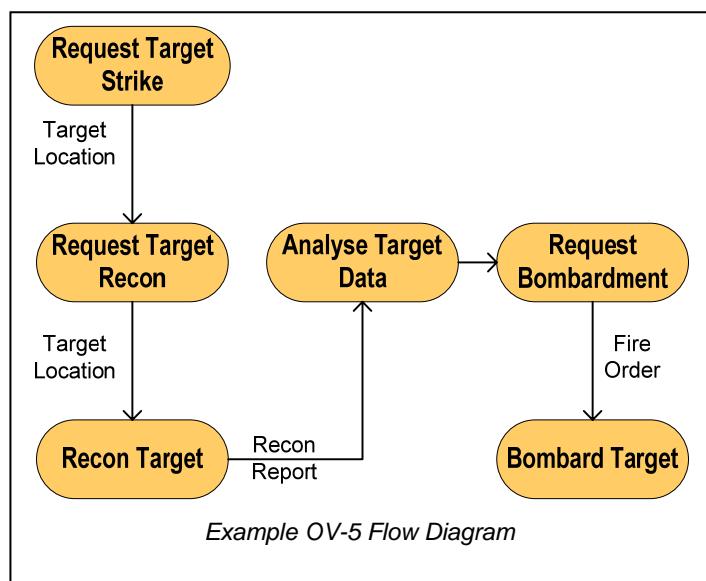

Example OV-5 Flow Diagram

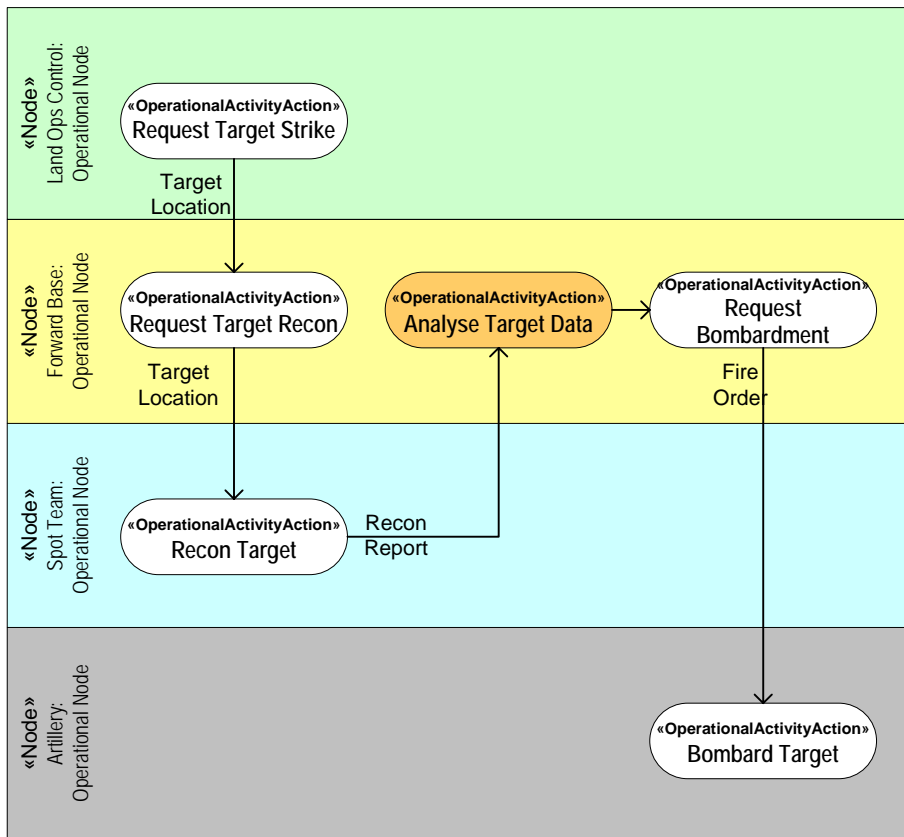

Example OV-5 Flow Diagram with Swimlanes

Alternatively, operational activities can be annotated (eg via the mechanism arrow in an IDEF0 diagram) with the corresponding node from OV-2.

If the Unified Modelling Language (UML) method is used, then the activity models can contain decision points and branching.

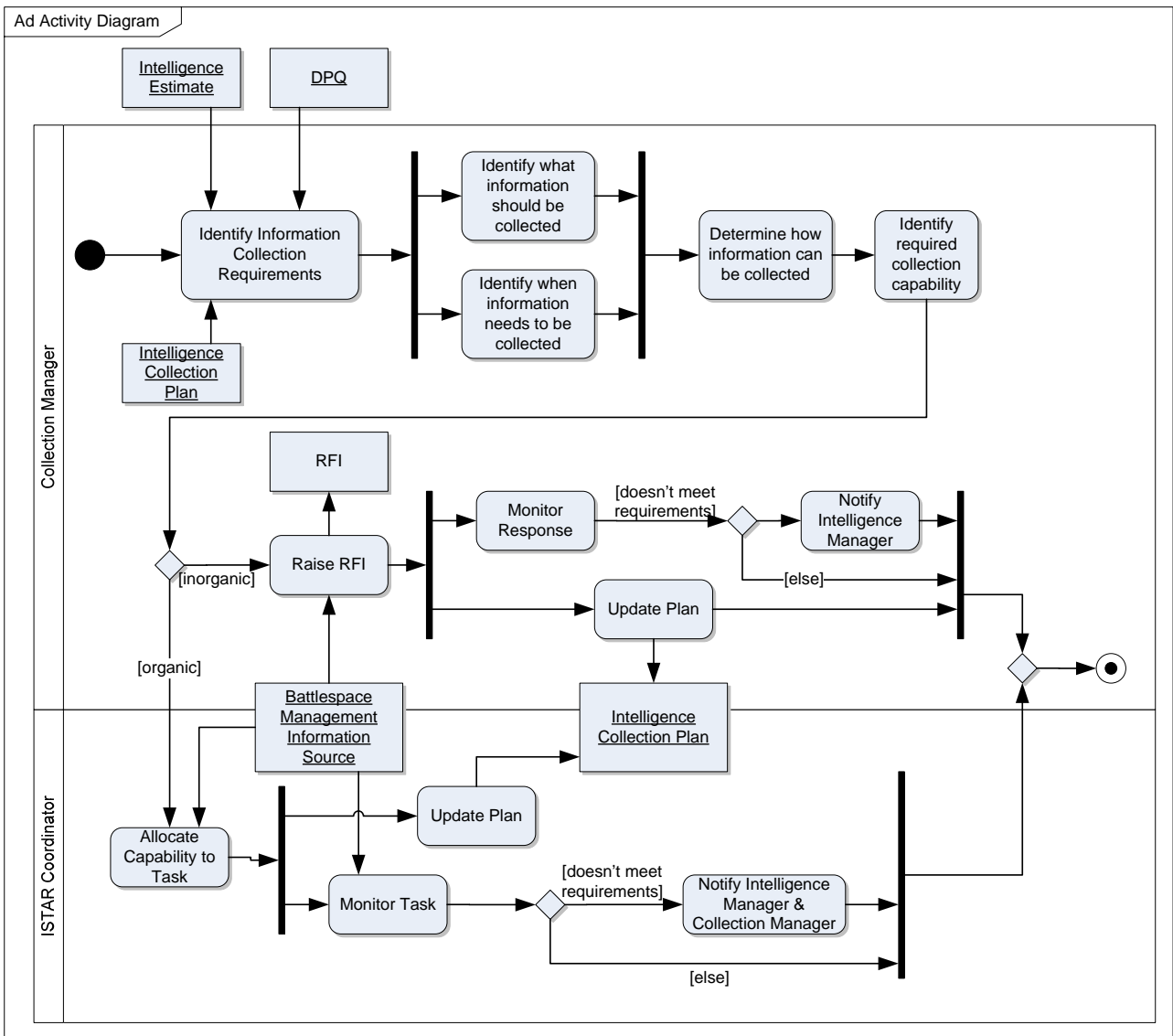

Complex OV-5 Flow Diagram with Swimlanes (UML)

If the Integration Definition for Function Modelling (IDEF0) method is used, the activities also show controls (factors that affect the way that the activity is performed) and may show mechanisms (the resources, including nodes, that perform the activity). While some may illustrate corresponding systems as mechanisms in this model, the reader is cautioned that the introduction of system data early in the development of the OV may result in limiting system design and implementation decisions.

The OV-5 may be used in conjunction with OV-6c, Operational Event Trace Diagram, to specify the sequence in which information exchanges take place. From a modelling perspective, operational activities can be designated as 'acting upon' particular information entities. This relationship between activities and information entities is different to the input / output flow relationship described above. This is intended to address information management types of activities where the information entity is the subject of some management action but is not necessarily part of an input-output activity flow.

As with OV-2 and OV-3, flows on an OV-5 may also carry materiel, human resources or energy.

## Service Oriented Architectures

If the architect is developing a Service Oriented Architecture (SOA), an OV-5 may be used to show which services are required to support the conduct of operational activities. This type of view is commonly termed a “service orchestration diagram”, because it helps define what services are needed to support an operation and when they are needed.

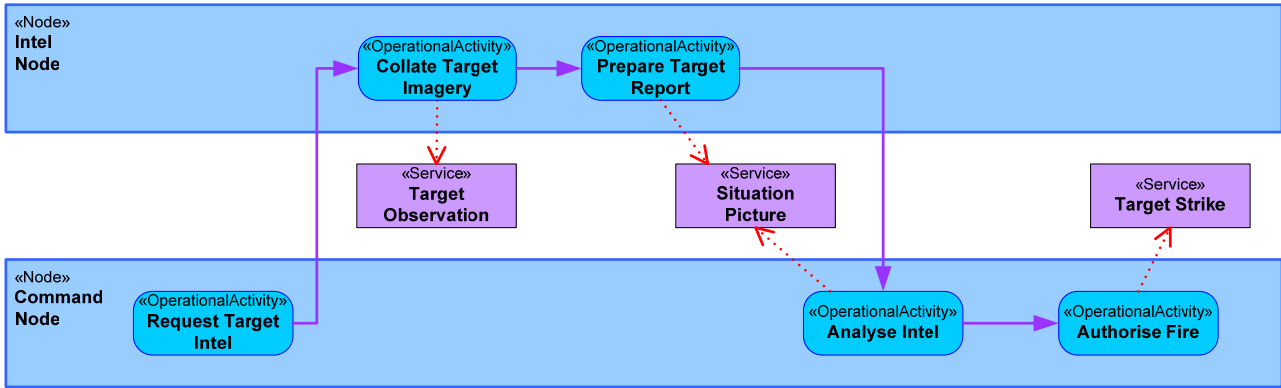

OV-5 Diagram with Services

### **Introduction to OV-6a, OV-6b and OV-6c**

Many of the critical characteristics of architecture are only discovered when the behaviour of the architectural elements is modelled. OV-5 provides a functional description of this behaviour. OV-6 augments this functional description with rules, states and sequences.

OV-6 consists of three views. The first (OV-6a) is not strictly a behavioural view – it specifies operational rules, which may be behavioural, or may simply be non-functional constraints. OV-6b describes the typical states a node may have and the possible transitions between those states. OV-6c augments the OV-3, Information Exchange Matrix, by outlining the sequence in which information exchanges take place between nodes.

The OV-6 views describe logical rules, states and sequences – i.e. they are specified independently of any given solution. SV-10 provides the solution-specific equivalent to OV-6, detailing the rules, states and sequences that derive from the OV-6 for a specific physical architecture.

## OV-6a - Operational Rules Model

An OV-6a specifies operational or business rules that are constraints on the way that business is done in the Enterprise.

### Background

At a top level, rules will at least embody the concepts of operations defined in OV-1a, High Level Operational Concept Graphic. These will also provide guidelines for the definition of more detailed rules and behavioural definitions that will be captured as the architecture is developed. (Rules can also be shown as constraints on other diagrams)

### Usage

- Definition of doctrinally correct operational procedures.
- Definition of business rules.
- Identification of operational constraints.

### Data objects

The data in an OV-6a can include:

- Operational constraints.
- Nodes.
- Operational Activities.
- Missions.
- Entities (from OV-7, Information Model).

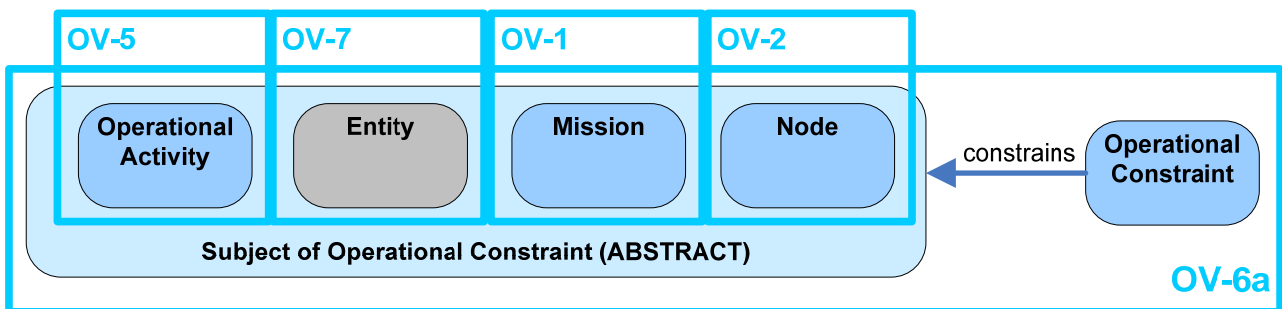

*Relationships between Key Data Objects (Simplified from M3)*

### Representation

- Structured Text.
- UML diagram with associated UML constraints.

## Detailed Product Description

The OV-6a specifies operational or business rules that are constraints on the way business is done in the enterprise. Whilst the other OVs describe the structure and operation of a business, for the most part they do not describe the constraints and rules under which it operates.

At the mission level, OV-6a may be based on business rules, such as those contained in doctrine, guidance, rules of engagement, etc. At lower levels, OV-6a describes the rules under which the architecture or its nodes behave under specified conditions. Such rules can be expressed in a textual form, for example:

*“If (these conditions) exist, and (this event) occurs, then (perform these actions).”*

These rules are contrasted with the business or doctrinal standards themselves, which provide authoritative references and provenance for the rules (see TV-1, Technical Standards View).

The rules captured in OV-6a are logical<sup>5</sup> whereas constraints that are specific to resources are defined in SV-10a, Resource Constraints Specification. OV-6a rules can include such guidance as the conditions under which operational control passes from one entity to another or the conditions under which a human role is authorised to proceed with a specific activity.

Rule ID	Applies to	Rule Specification
R1	All	All communications shall be encrypted to TS level according to CESG guidelines
R2	Conduct BDA (Operational Activity)	Battle Damage Assessment shall be carried out under fair weather conditions
R3	Make Re-Strike Decision (Operational Activity)	If Battle Damage Assessment shows incomplete strike then a re-strike shall be carried out

*Operational Rules Example (Structured Text)*

From a modelling perspective, operational constraints may act upon nodes, operational activities, missions and entities (OV-7). Consequently, OV-6a rules may be associated with activities in OV-5 and it is often useful to overlay the rules on an OV-5, Operational Activity Model (See diagram – right).

In this example, a rule “battle damage assessment shall be carried out under fair weather conditions” is shown linked to the “Conduct BDA” activity in the OV-5.

OV-6a can also be used to extend the capture of business requirements by constraining the structure and validity of OV-7, Information Model, elements.

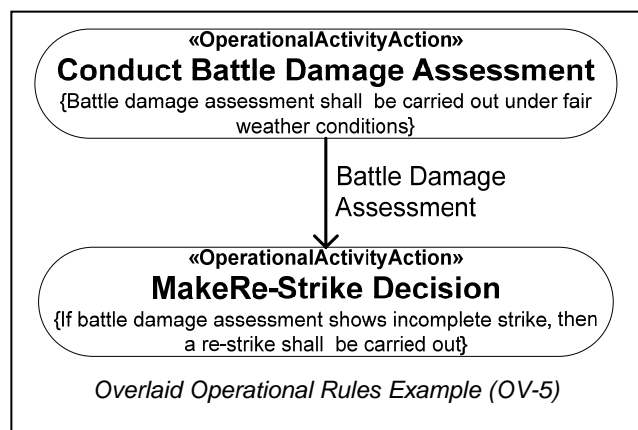

Detailed rules can become quite complex, and the structuring of the rules themselves can often be challenging. MODAF does not specify how OV-6a rules will be specified, other than being written in English.

<sup>5</sup> In abstract rather than physical terms, so as to be solution independent.

## OV-6b - Operational State Transition Description

The OV-6b is a graphical method of describing how a node changes in response events that affect it.

### Background

The OV-6b specifies the states a node can have, and the possible transitions (i.e. changes of state) between them. Triggers for state changes may also be defined.

### Usage

- Analysis of business events.
- Behavioural analysis.
- Identification of constraints (input to SRD).

### Data objects

The data in an OV-6b can include:

- States (each associated with a node).
- State transitions (each associated with an event).

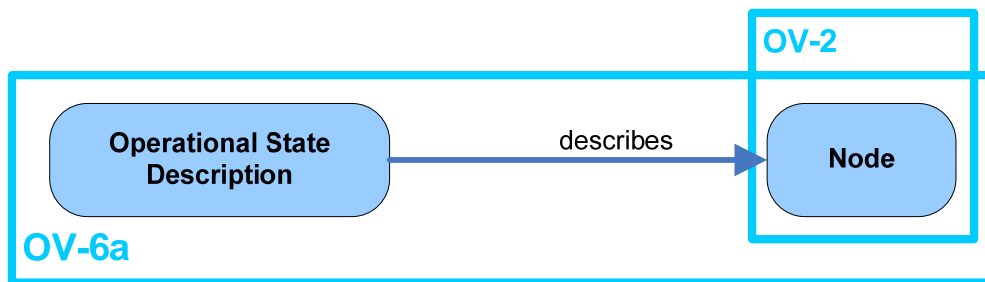

*Relationships between Key Data Objects (Simplified from M3)*

### Representation

- Topological (Connected Shapes).
- UML state diagram.

### Detailed Product Description

An OV-6a depicts states and state transitions for a node.

The Figure below, based on a State chart Diagram, provides a template for a simple OV-6b. The black dot and incoming arrow point to initial states (usually one per diagram), while terminal states are identified by an outgoing arrow pointing to a black dot with a circle around it. States are indicated by rounded corner box icons and labelled by name or number and, optionally, any actions associated with that state. Transitions between states are indicated by one-way arrows labelled with an event/action notation that indicates an event-action pair, and which semantically translates to: when an event occurs, the corresponding action is executed.



State transitions

The following figure provides an example view product.

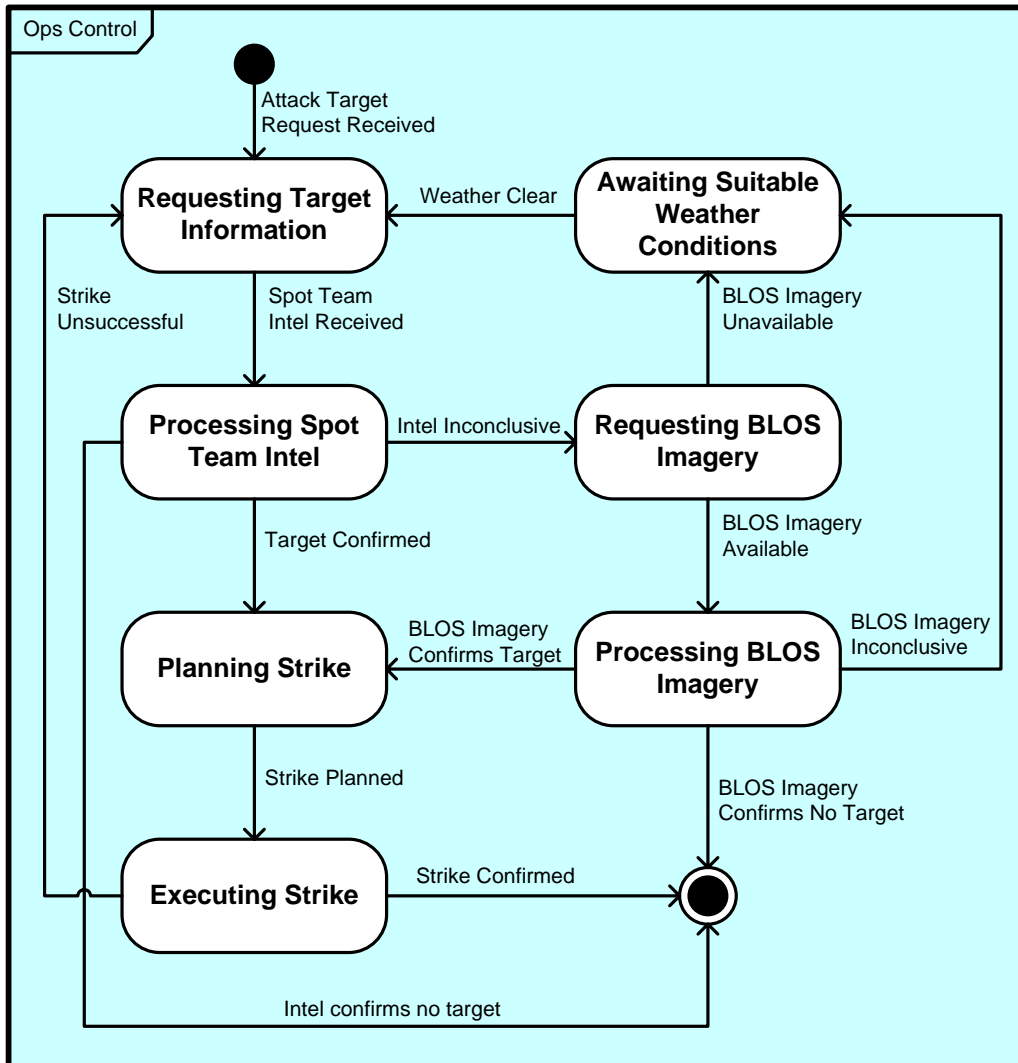

Example OV-6b

States in an OV-6b may be nested. This enables quite complex models to be created to represent operational behaviour.

## **OV-6c - Operational Event-Trace Description**

The OV-6c provides a time-ordered examination of the exchanges between participating nodes in a particular scenario. There may be multiple OV-6c products to represent different scenarios, and each event-trace diagram will have an accompanying description that defines the particular scenario or situation.

### **Background**

Operational Event-Trace Descriptions, sometimes called sequence diagrams, event scenarios or timing diagrams, allow the tracing of interactions between nodes in a scenario or critical sequence of events. The node interactions usually correspond to flows of information, but may optionally describe flows of energy, material or people. The OV-6c, along with OV-6b, Operational State Transition Description, and OV-5, Operational Activity Model, specify the behaviour of nodes.

OV-6c is valuable for increasing the level of detail from the initial operational concepts, and can help define node interactions and operational threads. It can also help ensure that each participating node has the necessary information it needs at the right time in order to perform its assigned operational activity.

### **Usage**

- Analysis of operational events.
- Sequences of interactions between nodes.
- Behavioural analysis.
- Identification of non-functional user requirements (input to URD).
- Operational test scenarios.

### **Data objects**

The data in an OV-6c can include:

- Lifelines (each associated with a node).
- Messages
- Information Elements

### **Representation**

- UML sequence diagram.

### **Detailed Product Description**

OV-6c allows the tracing of interactions in a scenario or critical sequence of events and can be used by itself or in conjunction with OV-5, Operational Activity Model, and/or an OV-6b to describe the dynamic behaviour of nodes in a mission or operational thread.

The diagram below shows the components of an OV-6c. The items across the top of the diagram are nodes. Each node has a vertical timeline associated with it. Specific points in time can be labelled running down the left-hand side of the diagram. Directed lines between the node time lines represent interactions (e.g. information exchanges) between nodes, and the points at which they intersect the timelines represent the times at which the nodes become aware of the events.

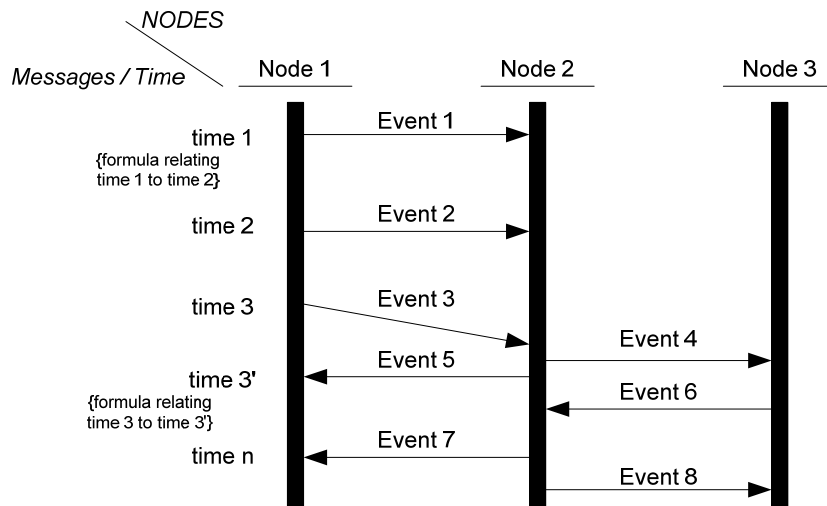

OV-6c Schematic

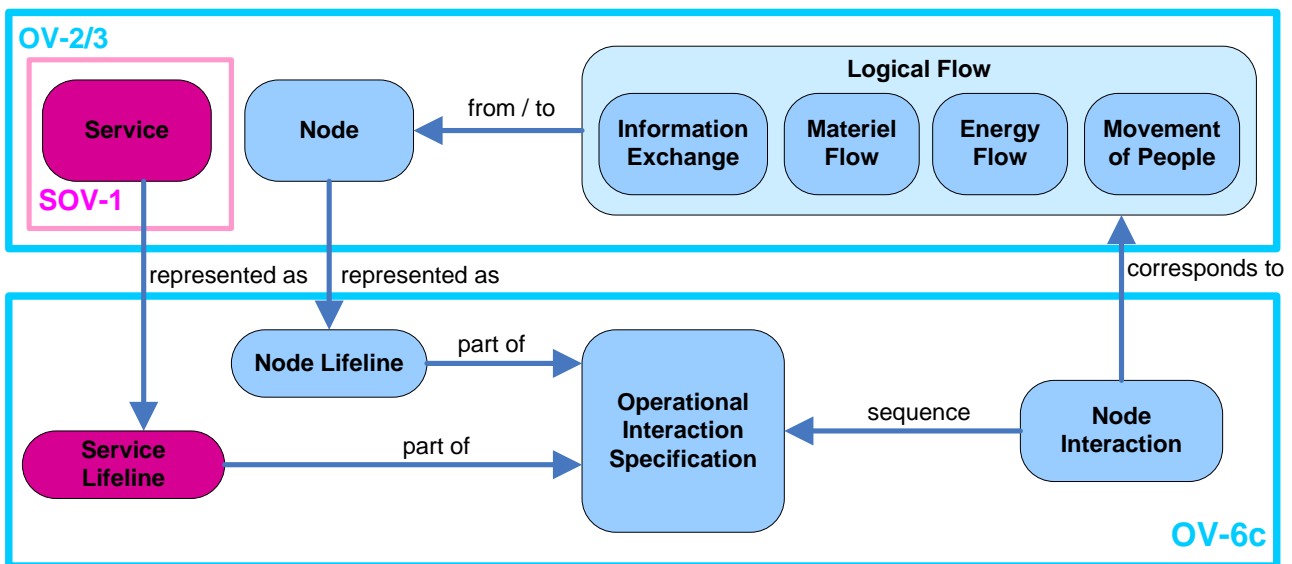

Relationships between Key Data Objects (Simplified from M3)

MODAF does not generally endorse a specific modelling methodology, however in the case of OV-6c, UML sequence diagrams seem the most appropriate. If UML cannot be used, an OV-6c may be developed using any modelling notation that supports the layout of timing and sequence of activities along with the information exchanges that occur between Nodes for a given scenario. Different scenarios will be depicted by separate diagrams.

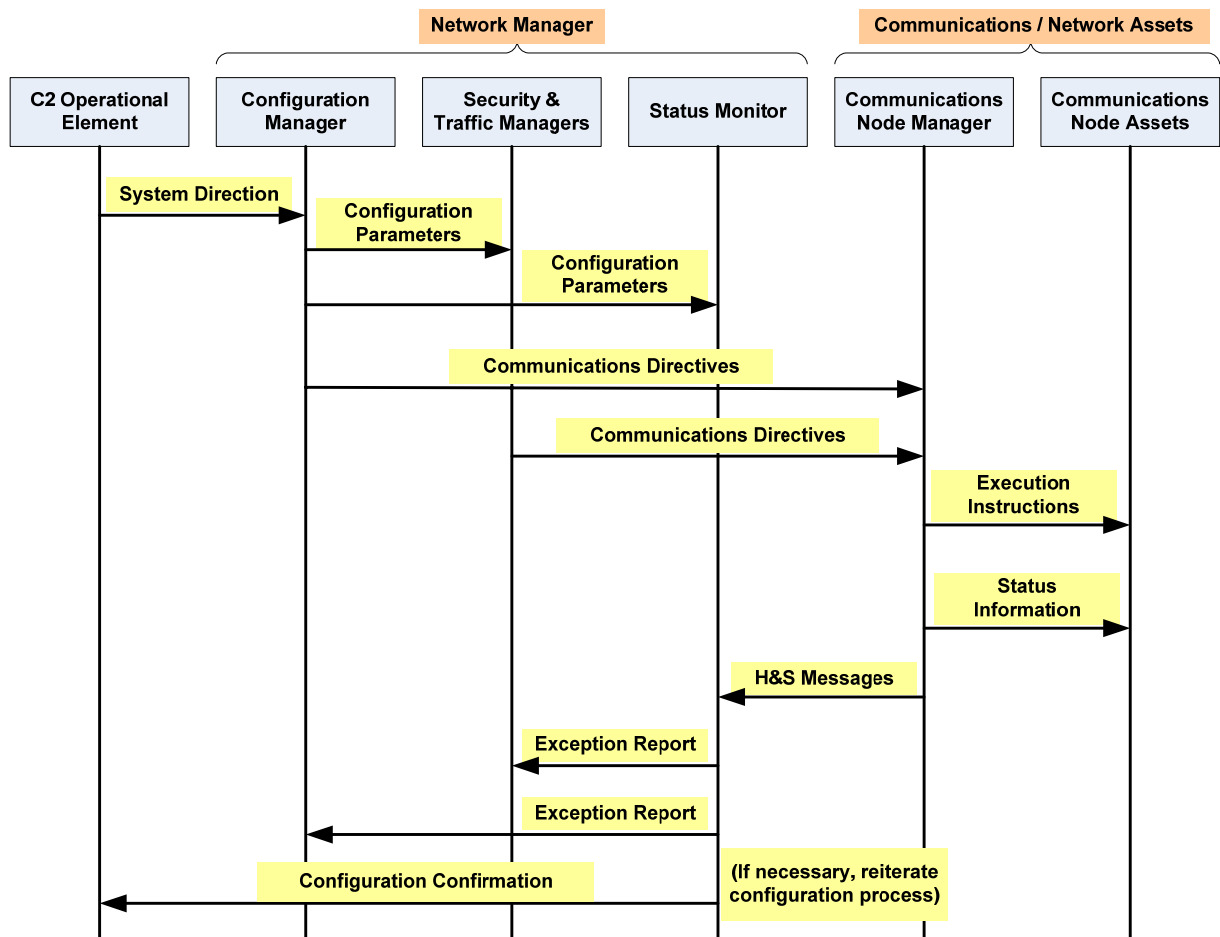

OV-6c Example)

The figure on the following page shows an example OV-6c Product using a UML sequence diagram.

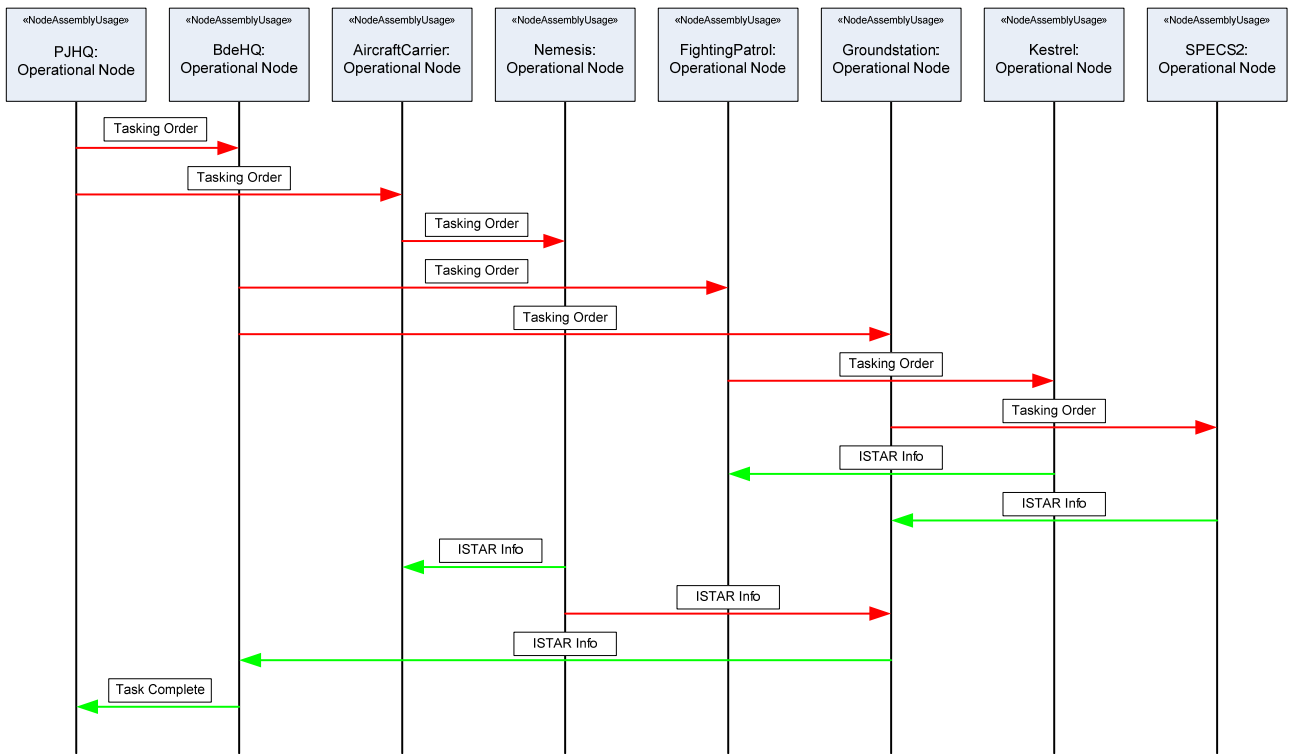

OV-6c Example

The information content of 'messages' that connect life-lines in an OV-6c view product may be related, in modelling terms, with the information flows, from OV-3 and OV-5, and information entities, from OV-7, Information Model.

### Service Oriented Architectures

If the architect is developing a Service Oriented Architecture (SOA), an OV-6c product may be used to show the sequence of interactions required to support operational activities. An "SOA OV-5" shows which services support which operational activities. However it may be useful to show how those services are required to interact in order to support operations. An "SOA OV-6c" shows lifelines for services, and the sequence of interactions between those services:

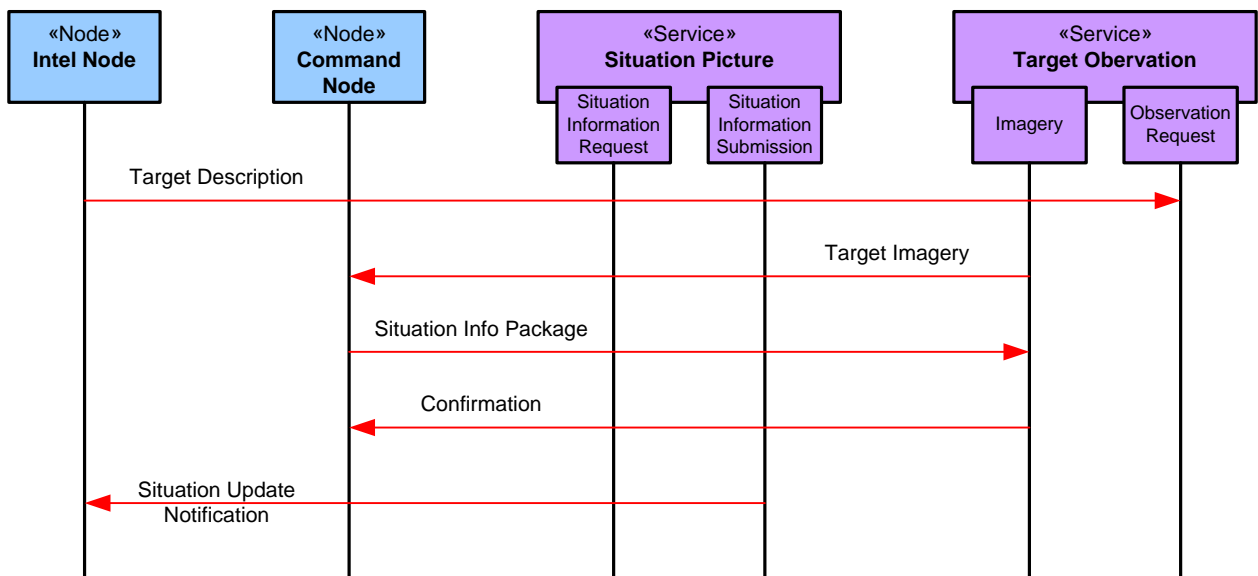

Services Example of OV-6c

## OV-7 - Information Model

The OV-7 addresses the information modelling perspective of an operational architecture.

### Background

The OV-7 is used to document the business information requirements of the enterprise. It describes the information that is associated with the information exchanges specified in OV-3, Information Exchange Matrix. An OV-7 defines a logical data model consisting of entities, attributes and relationships. The entities in the model define the structure of information elements that are exchanged between nodes.

### Usage

- Information architecture.
- Logical data modelling.

### Data objects

The data in an OV-7 can include:

- Logical Data Model.
- Entity.
- Attribute.
- Entity Relationship.

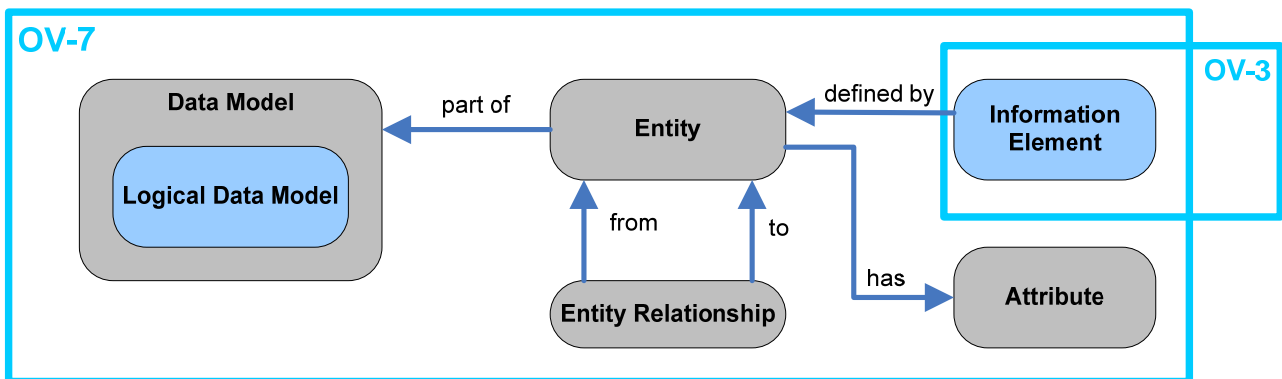

*Relationships between Key Data Objects (Simplified from M3)*

Note that an Entity within an OV-7 may define the structure of an Information Element in an OV-3, Operational Information Exchange Matrix.

### Representation

- Entity-Relationship diagram (e.g. IDEF1X)
- UML class diagram.

## Detailed Product Description

The OV-7 describes the logical data model for the architecture. It provides a definition of information types (entities), their attributes or characteristics, and their interrelationships.

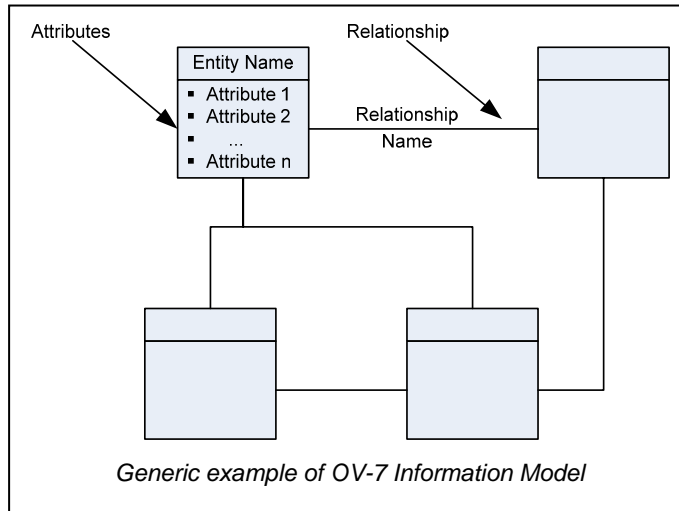

Note that MODAF refers to 'information' in the Operational Viewpoint and 'data' in the System Viewpoint. The intention of this is that OV-7 describes information of importance to the business (e.g. information products that might be referred to in doctrine, SOPs etc) whereas SV-11 describes data relevant at the system level.

OV-7 defines each kind of information class associated with the architecture domain, mission, or business as its own entity, with its associated attributes and relationships. These entity definitions specify the structure of OV-3 information.

Usually, an entity-relationship notation will be used for OV-7, but it is also possible to use UML (with appropriate M3 stereotypes) for OV-7. An example UML usage is shown below.

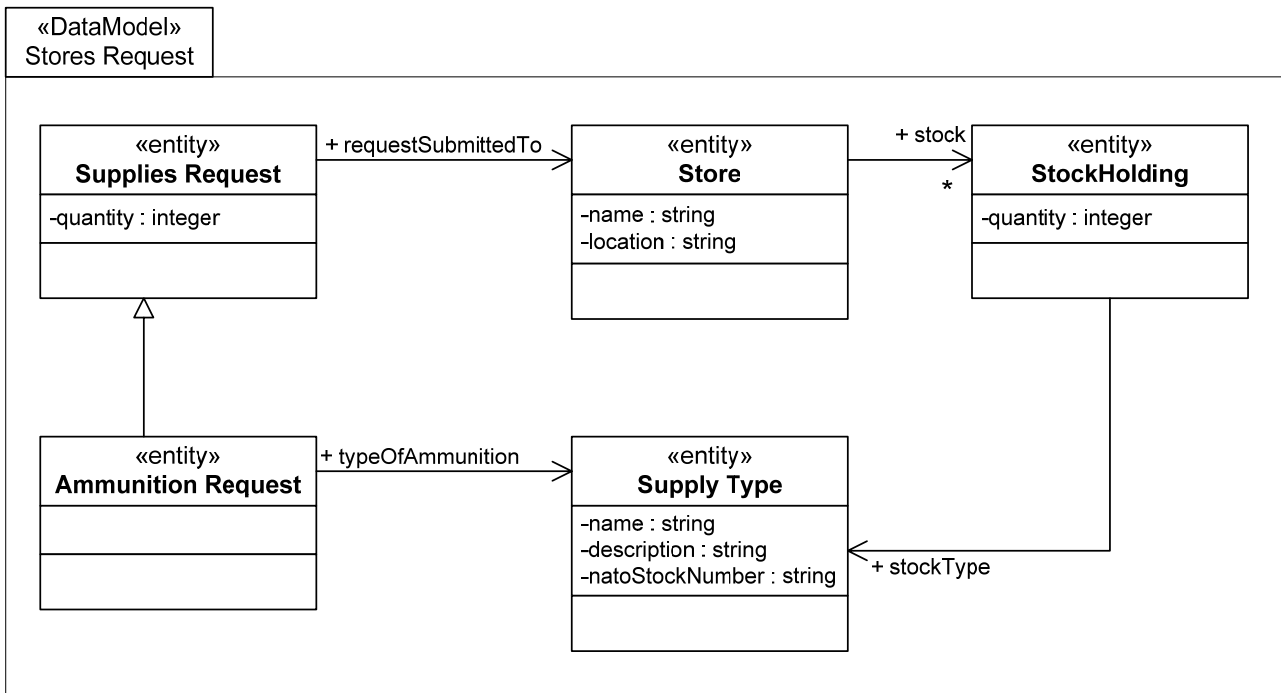

Example OV-7 (UML)